



Product Catalog

Full-line Industrial Products



Contents

01	General Information	5
02	Blower Silencers	7
03	Absorptive Silencers	24
04	Vent Silencers	31
05	Industrial Fan Silencers	35
06	Vacuum Pump Liquid Separator-Silencers	40
07	Engine Exhaust Silencers	48
08	Filters and Filter-Silencers	62
09	ASME Code	77
10	Accessories	79



All dimensions in inches and weights in pounds, unless otherwise indicated.
www.durr-universal.com



Company Profile



Dürr Universal has been part of the Dürr Group since 2018 and is a global provider of custom engineered ancillary equipment and solutions to the power generation, oil and gas, industrial processing, rail transportation, and backup power markets. For more than half a century, OEMs, EPCs, packagers, and end-users have relied on Dürr Universal to engineer acoustic and emission/filtration systems to meet their specific needs.

Our comprehensive single-sourced solutions meet environmental, regulatory, and operational requirements and help operators reduce costs, improve the efficiency of equipment, and achieve safety and compliance targets. We offer a systems portfolio featuring exhaust and inlet systems, including silencers, ducts, structural steel, dampers/diverters and filters for gas turbines, and diesel and natural gas engines.

We've been custom-engineering and perfecting ancillary equipment and solutions for more than a half century for both new and retrofit projects. We bring proven global experience with custom-designed systems installed on all major turbine brands. And we help customers around the world with applications from 5 megawatts to as large as several hundred megawatts meet clean, quiet air regulations safely and efficiently.

Dürr Universal manufactures a complete line of noise control and air filtration solutions for industrial processing within a wide range of industries, delivering thousands of quality components to the industrial power market each year. Whether your processing needs require standard silencing, custom silencing or filtration, we are your single source for a complete solution.

01

General Information

General Information _____

6

General Information

SILENCER SIZING

Proper silencer sizing requires the following information:

- A** exhaust flow rate (cfm)
- B** silencer inlet size (ft²)
- C** level of silencing required
- D** temperature

Calculate exhaust gas velocity by dividing the flow rate by the pipe area:

$$\frac{\text{exhaust flow rate (cfm)}}{\text{silencer inlet pipe area (ft}^2\text{)}}$$

Reference the pressure drop curve in the silencer spec sheets. Using the calculated exhaust gas velocity, find the corresponding estimated pressure drop on the curve. If you have selected a silencer that achieves your silencing level requirements at an acceptable pressure drop level, you have identified the silencer that is right for you!

SELECTION ASSISTANCE

If you need help with silencer selection and sizing, please contact your nearest Dürr Universal office. A list of locations and phone numbers are available on our website at: www.durr-universal.com or you can call: +1 888 300-4272.

SILENCER PAINTS

Paints are selected based upon ISO 12944:2018 Paints and varnishes - Corrosion protection of steel structures by protective paint systems for C1/C2 environments. An outdoor application requires a two coat primer topcoat paint system. A product with rust inhibitive primer may be top coated in the field. Alternate paint colors are available, but may require a different paint system. High humidity, coastal, marine, or aggressive environments are not supported by the standard paints and a specialty paint system is recommended.

NOTES

Keep in mind that silencers are not designed to support their weight from the inlet or outlet tube, or support other components of the exhaust system, such as stacks. For the most efficient operation of all silencing units, proper mounting attachments are required. Request a product-specific IOM (Installation and Operation Manual) from our customer service team for further information.

02

Blower Silencers

General Information _____	10
Application, Capacity, Pressure Drop Data _____	11
Specifications UCI Group _____	12
Specifications RIS Group _____	13
Specifications UCD Group _____	14
Specifications URB Group & URD Group _____	15
Specifications SD Group _____	16
Specifications RD Group _____	17
Specifications SURS Group _____	18
Accessories and Optional Features _____	19
CB Series _____	20
CBF/CBFI Series _____	21
UNI-BASE Plates/Components _____	22

Blower Silencers

In a closed blower discharge system, structure-borne noise—such as that radiated by pipe wall and silencer shell—may be a consideration, particularly where a stringent, close-proximity noise specification applies. For these applications, various means are available to treat the pipe and shell radiated noise, such that most reasonable specifications may be met.

For instance, it is possible to lag the silencer shell externally and reduce any shell noise contribution to below the casing and mechanical noise of the blower and driving machinery.

Dürr Universal invites your inquiries concerning special applications where EPA, OSHA, or other noise specifications apply. Special applications are handled on an individual basis and recommendations are made according to specific requirements of the installation.

ROTARY POSITIVE BLOWERS

The Rotary Positive Blower is a two impeller compressor that delivers a large quantity of gas or air relative to the individual pulses. Blower capacities are expressed in CFM at inlet conditions (ICFM). Blower size is usually expressed as gear diameter by rotor length. Pitch Line Velocity (PLV) is the peripheral velocity of the timing gear—equal to the product of the gear circumference and the rotative speed of the blower, usually expressed in feet per minute (FPM).

The blower presents two problems:

- 1) pulsation within the piping system and,
- 2) noise radiation in the vicinity of the blower and piping.

The importance of these relative to each other is a function of blower size and speed; both increase proportionately to the blower size and the square of the speed.

Pulsation is more pronounced on the discharge side. Peak pulse pressures are quite severe and can result in unsilenced discharge sound power levels up to 140–145 dB. The inlet, although producing less severe pulsation and noise, receives equal attention since the inlet is usually open to atmosphere and the noise much more apparent.

SILENCERS

There is little question that silencers are a necessity on any blower installation. Regardless of the size or speed of the blower, silencers of some type are nearly always used. In the selection of blower silencers, there are two basic considerations: 1) the silencer must be the correct size (i.e., sufficient capacity for the volume flow) and, 2) the silencer must be the proper type for the application. The nominal silencer size need only be based on the gas volume (i.e., the CFM of the gas or air at the operating conditions). However, the silencer (design) must be selected with consideration of the blower size and operating speed. Complete application and capacity information is given on page 11.

There are three types of silencers commonly used on rotary positive blowers: a reactive type silencer which consists of a series of expansion chambers having interconnecting tubes or a combination chamber-absorptive design which is similar to the reactive type with the exception that an acoustically-packed, sound absorbing section is included, comprising an extension of the silencer connection closest to the blower. The inlet of a discharge silencer and the outlet of an inlet silencer are the ends having the packed section.

A third basic type of silencer—straight-through packed type—is occasionally used on blowers. This type of silencer is usually used on small, high speed machines which characteristically produce significant high frequency noise and relatively mild pulsations.

The PLV is normally the criterion for silencer type selection. If the blower is operating in the critical PLV range, it will generate objectionable high frequency noise which may cause shell ring or tank hammer in the piping and silencer. These critical PLV conditions will always require a combination chamber-absorptive silencer for satisfactory results.

INLET SILENCERS

For inlet service, a PLV of 3,300 ft/min or greater is considered critical. This transition speed is empirically established and is somewhat arbitrary, however, it is commonly accepted that blowers operating at or above 3,300 ft/min are considered critical for the purpose of inlet silencer application. Those operating below 3,300 ft/min are considered subcritical. Subcritical PLV applications can usually be silenced adequately with a chamber-type silencer, such as Dürr Universal URB or UCI Series. Blowers operating above the critical PLV of 3,300 ft/min will require the RIS Series combination chamber absorptive type silencer. Inlet Filters or Filter Silencers are commonly used on blower inlets, either individually or in series with a separate inlet silencer. Please reference the Filters and Filter Silencers section of this catalog for further information.

DISCHARGE SILENCERS

For the more severe discharge conditions of typical blower installations, a PLV of 2,700 ft/min is accepted as the critical transition speed. Blowers operating below 2,700 ft/min are considered subcritical and can usually be adequately silenced on the discharge side by use of a chamber-type silencer UCD or URD Series. Machines operating above the 2,700 ft/min transition speed will require combination chamber-absorptive silencers such as SD or RD Series.

In some larger blower installations, piping requirements or space restrictions may preclude the use of a large, single discharge silencer such as the SD or RD Series.

Where two or more blowers discharge into a common header, individual silencers upstream of the header are required to subdue the individual blower pulsations. Otherwise, the pulsations tend to beat with each other and can be extremely objectionable.

Note: Silencers should be mounted as close to the blower as possible since any piping between the blower and silencer will radiate noise. Standard silencer connections are not designed to carry external piping or valve loads, so good piping support practices should be used to prevent stresses that cause fatigue and eventual fracture of the silencer or piping. It is also good practice to isolate the blower from the silencer with a flexible expansion joint. Contact Dürr Universal for special design considerations where loading is a factor. Also, see Dürr Universal's Blower Silencer IOM.

ATTENUATION CURVES

Noise attenuation curves are given for the various models within this section. The curves represent insertion loss of airborne noise for typical applications under average conditions. It is not feasible to chart the expected performance of a silencer over a wide range of applications and conditions, therefore, the curves must be used with discretion. Structure-borne noise may be a consideration and will require separate analysis, since it is not airborne noise and not used for silencer performance rating.

General Information

Rotary Positive Blowers

The silencers shown below are more fully described on the individual catalog pages. These units are designed specifically for use on Rotary Positive Blowers. There are fundamental similarities between blower silencers and other types, particularly reciprocating engine silencers, which also require a silencer design that provides effective pulse control as well as noise attenuation. However, blower silencers generally must be constructed more ruggedly to withstand prolonged exposure to severe pulsations produced by the blower. All silencers described are of standard with end-in, end-out design. Low or high side inlet and outlet connections are available and are described on the individual catalog pages.

TECHNICAL PRESENTATION

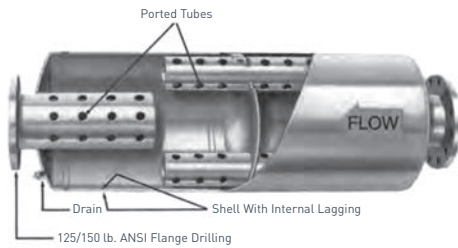

UCI SERIES INLET SILENCER

Chamber-type inlet silencer for use on subcritical PLV applications. Available in pipe sizes 8"–14". Smaller sizes use URB Series. Available with side connections and mounting brackets.

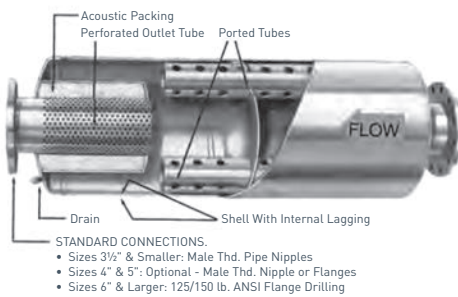

RIS SERIES INLET SILENCER

Combination chamber-absorptive type inlet silencer for critical PLV applications. Available in pipe sizes 2"–16". Low or high side outlet and mounting brackets available on most sizes.

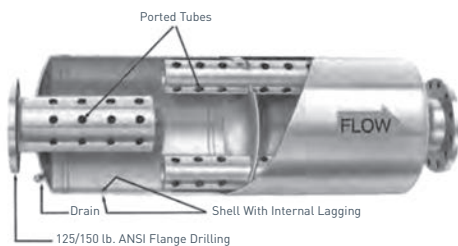

URB SERIES (UP TO 8")

URD SERIES (8"-14")

DISCHARGE SILENCER

Chamber-type discharge silencer for use on sub-critical PLV applications. Available in pipe sizes 8"–14". (Smaller sizes use URB Series.) Low, high, or opposed side connections and mounting brackets available.

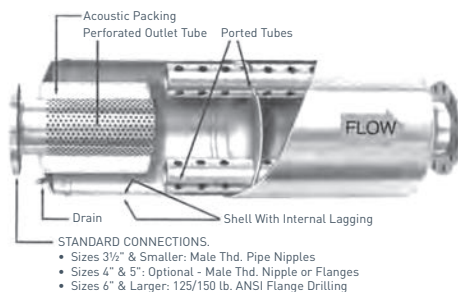

SD SERIES

RD SERIES

DISCHARGE SILENCERS

Combination chamber-absorptive type discharge silencers for critical PLV applications. Available in pipe sizes 2"–14". Low, high, or opposed side connections and mounting brackets available on most sizes.

ACCESSORIES, SPECIAL FEATURES

- Mounting Brackets
- Inspection Openings
- Pressure Vessel Construction
- Oversize Flanges
- Special Finishes
- Special Materials

Application, Capacity, Pressure Drop Data

SILENCER RECOMMENDATIONS

As mentioned on page 8 pitch line velocity (PLV) is the speed of the timing gear in feet per minute (ft/min). For purposes of silencer application PLV is considered “critical” at 3,300 ft/min for intake and 2,700 ft/min for discharge.

Table 1 gives transition speeds in RPM. Blowers running at these speeds or greater will have critical PLV. Operating speeds below transition will be in the sub-critical range. Blowers operating in the sub-critical speed range usually require only simple chambertype silencers while those in the critical range require combination chamber-absorptive type silencers. If there is doubt, it is best to use the combination-type silencers. When gear size and operating speeds are known, the proper type silencer is easily selected.

SILENCER SIZE SELECTION, CAPACITY

Table 4 gives the nominal capacity of the various size silencers. “Size” in this table refers to the silencer “nominal size,” or its “inlet size.” Capacities are expressed in inlet CFM (ICFM), thus, discharge silencers are rated at higher capacities than inlet silencers since the air is compressed to reduced volume at the discharge operating pressure.

- A From Table 1 determine whether blower RPM is above or below the transition speed for critical PLV.
- B Consult Table 2 for recommended silencer models.

PRESSURE DROP

The following formulas may be used to calculate pressure drop through the silencers covered in this catalog.

$$\text{Inlet: } \Delta P = \left(\frac{V}{4005} \right)^2 c$$

(assumes silencer inlet is open to atmosphere)

$$\text{Discharge: } \Delta P = \left(\frac{V}{4005} \right)^2 c \times \frac{P}{14.7} \times \frac{530}{T}$$

ΔP = pressure drop through silencer, inches of water

V = air velocity through silencer, ft/min*

c = individual silencer restriction coefficient—empirical constant (see Table 4)

P = discharge pressure, PSIA (operating pressure in PSIG + 14.7)

T = discharge temperature, °R absolute (operating temperature in °F + 460)

* To calculate velocity through silencer, divide flow in ACFM by cross-sectional area of silencer inlet diameter in square feet.

1 BLOWER TRANSITION SPEED		
Blower Gear Size	Transition Speed-RPM	
	Inlet	Discharge
2	6,300	5,155
2½	5,040	4,125
3	4,200	3,435
4	3,150	2,575
5	2,520	2,060
6	2,100	1,720
7	1,800	1,470
8	1,575	1,290
10	1,260	1,030
12	1,050	860
14	900	735
16	785	645
18	700	570
20	630	515
22	570	470
24	525	430

2 SILENCER MODEL SPECIFICATIONS		
Pitch Line	Inlet Silencer	Discharge Silencer
Below Transition	UCI, URB	URB, UCD, URD
Above Transition	RIS	SD, RD

4 PRESSURE DROP COEFFICIENTS	
Model	Pressure Drop Coefficient (C)
URB, URBY UCI, UCIY, UCIH	4.2 4.2
RIS, RISY, RISH UCD, UCDY	4.2 4.2
URD, URDY, URDH, SD, SDY, SDH	4.2 4.2
RD, RDY, RDH RDS, SDS, URDS	4.2 7.0

3 SILENCER CAPACITY						
Size	Capacity (Inlet CFM 14.7 PSIA at 70°F)					
	Inlet Silencer	Discharge Silencer				
		4 PSIG	6 PSIG	8 PSIG	10 PSIG	15 PSIG
1	30	35	40	40	40	45
1½	70	80	85	90	95	105
2	120	140	150	160	165	185
2½	190	220	235	245	255	285
3	270	320	335	355	370	415
3½	370	430	455	480	505	560
4	480	560	600	630	660	735
5	750	880	935	985	1,030	1,150
6	1,080	1,260	1,340	1,410	1,480	1,650
8	1,920	2,250	2,390	2,510	2,630	2,940
10	3,000	3,520	3,730	3,930	4,110	4,590
12	4,300	5,070	5,370	5,660	5,920	6,600
14	5,900	6,890	7,310	7,700	8,060	8,990
16	7,700	9,000	9,550	10,000	10,500	11,800
18	9,700	11,400	12,100	12,700	13,300	14,900
20	12,000	14,000	14,900	15,700	16,400	18,400
22	14,500	17,000	18,100	19,000	19,900	22,200
24	17,300	20,200	21,500	22,600	23,700	26,400
26	20,300	23,800	25,200	26,600	27,800	31,000
28	23,500	27,600	29,300	30,800	32,200	36,000
30	27,000	31,700	33,600	35,400	37,000	41,300
Est Temp.	70°F	115°F	140°F	165°F	190°F	240°F

Specifications UCI Group

Chamber Type Inlet Silencer

The UCI Series Inlet Silencer is a heavy-duty, all-welded unit offering standard attenuation. Silencers are constructed of carbon steel, designed to provide long service life. The UCI Series is designed for pulse control and silencing for most subcritical PLV applications.

Silencers are designed for either vertical or horizontal mounting. Designs will allow for low or high side outlets for mounting flexibility. Low side outlet versions are designated as "UCIY" and the high side outlet versions are designated as "UCIH."

The standard primer paint applied to exterior surfaces is a single-coat satin light blue alkyd primer rated for 325°F. A finish top coat may be applied in the field. Other coating options are available upon request. Brackets and other mounting options are also available. Silencers with connection sizes of 8" and above are equipped with 125/150# ANSI Drilled Plate Flanges. Please note all side inlet designs have dual drains. Contact your Dürr Universal rep for updated drawing.

Typical Attenuation Curve

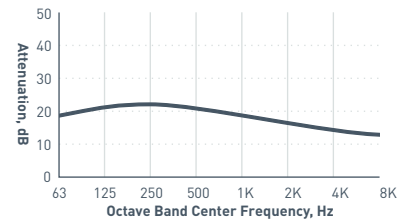

TECHNICAL PRESENTATION

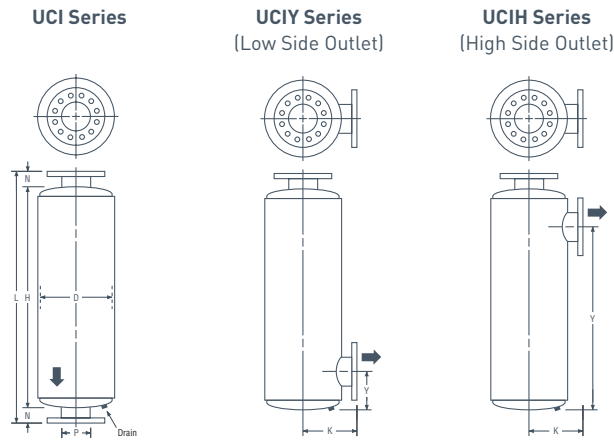

CHAMBER TYPE INLET SILENCERS

P (Size)	Part Number	D	L	N	H	K	UCIY		Y	UCH		Weight
							Min	Max		Min	Max	
1												
1½												
2												
2½												
3	Sizes 1"–6" use URB Series											
3½												
4												
5												
6												
8	53-108-AA	22	61	3½	54	14½	9	21	28½	45½	250	
10	53-110-AA	26	74	3½	67	16½	11	27	34½	57	360	
12	53-112-AA	30	87	3½	80	18½	12½	34	41	69	550	
14	53-114-AA	30	99	3½	92	18½	13½	40	47½	80½	650	

For silencer inlet sizes above 14" please contact Dürr Universal for price and availability.

Note: Dimensions (in) and weights (lbs) are nominal and may vary slightly with production models. Request certified drawings of specific models for exact dimensions.

Specifications RIS Group

Combination Chamber - Absorptive Type Inlet Silencer

The RIS Series Inlet Silencer is a heavy-duty, all-welded unit offering premium attenuation. Silencers are constructed of carbon steel, designed to provide long service life. The RIS Series is designed for pulse control and silencing for most Critical PLV Applications.

Silencers are designed for either vertical or horizontal mounting. A low side outlet version is designated RISY Series. Both the RIS and RISY Series Silencers have the same performance characteristics.

Silencers with connection sizes of 3-1/2" and smaller are offered with Male NPT Threaded connections. Silencer with connection sizes of 4" and 5" are available with either NPT male threads, or flanges. Silencer connections of 6" and above are equipped with 125/150# ANSI Drilled Plate Flanges. The standard primer paint applied to exterior surfaces is a single-coat satin light blue alkyd primer rated for 325°F (160°C). A finish top coat may be applied in the field. Other coating options are available upon request. Brackets and other mounting options are also available. Please note all side inlet designs have dual drains. Contact your Dürr Universal rep for updated drawing.

Typical Attenuation Curve

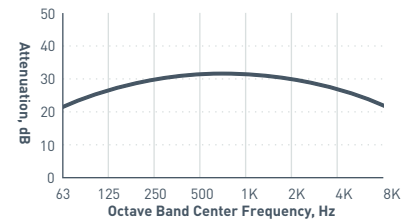

TECHNICAL PRESENTATION

RIS Series



RISY Series
(Low Side Outlet)

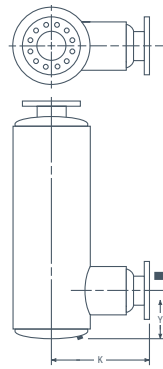

COMBINATION CHAMBER-ABSORPTIVE TYPE INLET SILENCERS

P (Size)	Part Number	D	L	N	H	K RISY	E	RISY		Y Weight
								Min	Max	
1	Sizes 1" - 1½" use U5 Series (page 27)									
1½										
2	54-102-AA	8	28½	3	22½	8½	—	FIXED AT 6		25
2½	54-125-AA	8	33	3	27	9	—	FIXED AT 7		25
3	54-103-AA	8	39	3	33	10	—	FIXED AT 7		30
3½	54-135-AA	10	39½	3	33½	11	—	FIXED AT 8		40
4	54-104-AA*	10	45	3	39	12½	2¼	7½	16½	50
5	54-105-AA*	12	57½	3	51½	15½	2¾	9	23	80
6	54-106-AA	14	64	3	58	17	3¼	9	25½	110
8	54-108-AA	18	72	3½	65	21½	4	12	30½	190
10	54-110-AA	22	85	3½	78	25½	5	13½	37	380
12	54-112-AA	26	98	3½	91	29½	6	15	44	550
14	54-114-AA	30	111	3½	104	30	7½	16½	50	800
16	54-116-AA	36	113	3½	106	35½	0	18½	51	1,050

Acoustical packing is suitable up to 325°F.

For connection sizes above 16" please contact Dürr Universal for price and availability.

Note: Dimensions (in) and weights (lbs) are nominal and may vary slightly with production models. Request certified drawings of specific models for exact dimensions.

*Specify -TT for male pipe threaded units.

Specifications UCD Group

Chamber Type Discharge Silencer

The UCD Series Discharge Silencer is a heavy-duty, all-welded unit offering standard attenuation. Silencers are constructed of carbon steel, providing long service life. The UCD Series is designed for pulse control and silencing for most Sub Critical PLV Applications. For Premium Grade Silencing, please refer to the URD Series.

The UCD Series is the basic end-in, end-out configuration. A low side inlet version is offered as the UCDY Series. Silencers are designed for either vertical or horizontal mounting. Silencers with connection sizes of 8" and above are equipped with 125/150# ANSI drilled plate flanges.

The standard primer paint applied to exterior surfaces is a single-coat satin light blue alkyd primer rated for 325°F. A finish top coat may be applied in the field. Additional coating options are available upon request. Brackets and other mounting options are also available. Please note all side inlet designs have dual drains. Contact your Dürr Universal rep for updated drawing.

Typical Attenuation Curve

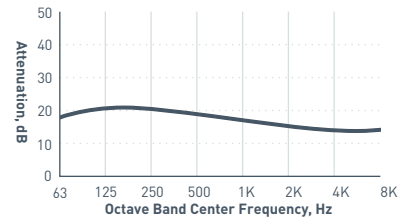

TECHNICAL PRESENTATION

UCD Series

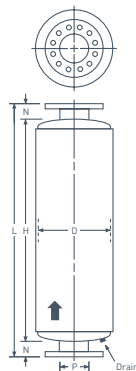

UCDY Series
(Low Side Inlet)

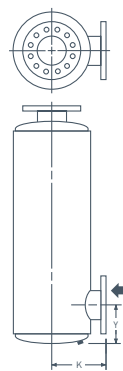

CHAMBER TYPE DISCHARGE SILENCERS

P (Size)	Part Number	D	L	N	H	K	Y		Weight
							Min.	Max	
1									
1½									
2									
2½									
3									
3½									
4									
5									
6									
8	56-108-AA	22	61	3½	54	14½	9	21	250
10	56-110-AA	26	74	3½	67	16½	11	27	360
12	56-112-AA	30	87	3½	80	18½	12½	34	550
14	56-114-AA	30	99	3½	92	18½	13½	40	650

Sizes 1"–6" use URB Series (page 15)

For connection sizes above 14" please contact Dürr Universal for price and availability.

Note: Dimensions (in) and weights (lbs) are nominal and may vary slightly with production models. Request certified drawings of specific models for exact dimensions.

Specifications URB Group & URD Group

Chamber Type Inlet & Discharge Silencer

The URB/URD Series Discharge Silencer is a heavy-duty, all-welded unit offering premium attenuation. Silencers are constructed of carbon steel, providing long service life. The URB/URD Series is designed for pulse control and silencing for most subcritical PLV applications.

The URB/URD Series is the basic end-in, end-out configuration. A low side inlet (URBY/URDY), high side inlet (URDH), and opposed connection (URDS) versions are available providing added mounting and piping flexibility. Silencers are designed for either vertical or horizontal mounting. Silencers with connection sizes of 8" and above are equipped with 125/150# ANSI drilled plate flanges.

Connection sizes of 3-1/2" and smaller are offered with male NPT pipe threads. Connection sizes of 4" and 5" are available with either male NPT thread or 125/150# ANSI drilled plate flanges. The standard primer paint applied to exterior surfaces is a single-coat satin light blue alkyd primer rated for 325°F. A finish top coat may be applied in the field. Other coating options are available upon request. Brackets and other mounting options are also available. Please note all side inlet designs have dual drains. Contact your Dürr Universal rep for updated drawing.

Typical Attenuation Curve

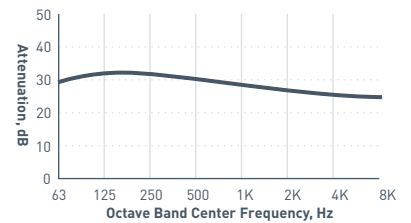

TECHNICAL PRESENTATION

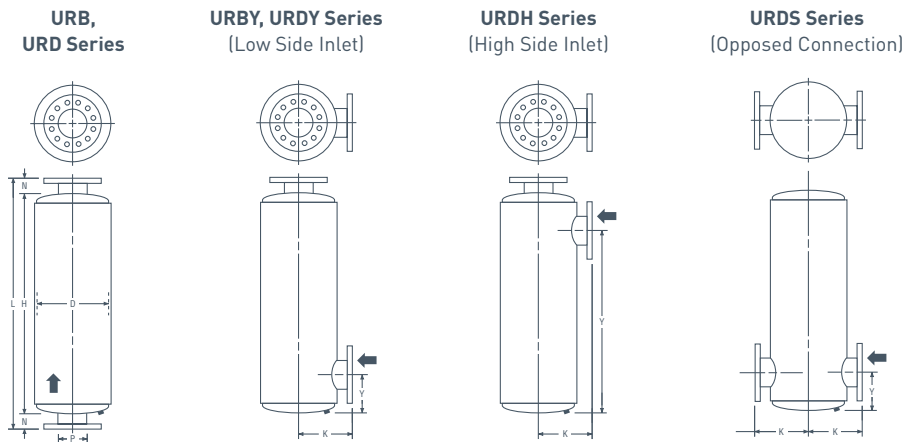

CHAMBER TYPE DISCHARGE SILENCERS

P (Size)	Part Number	D	L	N	H	K	URBY, URDY		Y URDH		URDS		Weight
							Min	Max	Min	Max	Min	Max	
1	55-101-AA	4½	21	2	17	—	—	—	—	—	—	—	10
1½	55-115-AA	6½	24	2	20	—	—	—	—	—	—	—	15
2	55-102-AA	8	33	3	27	7	FIXED AT 6		—	—	—	—	20
2½	55-125-AA	10	34	3	28	8	FIXED AT 7		—	—	—	—	30
3	55-103-AA	10	46	3	40	8	FIXED AT 7		—	—	—	—	40
3½	55-135-AA	12	52	3	46	9	FIXED AT 8		—	—	—	—	55
4	55-104-AA*	14	53	3	47	10	6	22	—	—	8	16	70
5	55-105-AA*	16	65	3	59	11	6½	29	—	—	9	19	120
6	55-106-AA	18	72	3	66	12	8	32	—	—	10	22	160
8	55-108-AA	22	97	3½	90	14½	9	48	62	82	12	29	370
10	55-110-AA	26	122	3½	115	16½	11	63½	76½	106	14	40½	550
12	55-112-AA	30	135	3½	128	18½	12½	69	88	117½	15½	42	800
14	55-114-AA	36	161	3½	154	21½	14½	81	107	141	17½	49	1,250

For connection sizes above 14" please contact Dürr Universal for price and availability.

Note: Connection sizes of 1" – 6" are designated as URB Series. Sizes 8" and larger are designated as URD Series. Both the URB and URD Series are fundamentally the same in design and the performance characteristics are identical.

Dimensions (in) and weights (lbs) are nominal and may vary slightly with production models. Request certified drawings of specific models for exact dimensions.

*Specify -TT for male pipe threaded units.

Specifications SD Group

Combination Chamber-Absorptive Type Discharge Silencer

The SD Series Discharge Silencer is a heavy-duty, all-welded unit offering standard attenuation. Silencers are constructed of carbon steel, designed to provide long service life. The SD Series is designed for pulse control and silencing for most critical PLV applications. For the most demanding pulse applications, the RD group of silencers may be required.

Silencers are designed for either vertical or horizontal mounting. Designs will allow for low or high side inlets for mounting flexibility. A low side inlet version is designated SDY Series. The high side inlet configuration is designated as SDH Series. The opposed connection version is designated as the SDS Series. All versions have the identical performance characteristics.

Silencers with connection sizes of 2" to 3-1/2" are offered with male NPT threaded connections. Silencers with connection sizes of 4" and 5" are available with either NPT male threads, or drilled plate flanges. Silencer connections of 6" and above are offered with 125/150# ANSI drilled plate flanges. The standard primer paint applied to exterior surfaces is a single-coat satin light blue alkyd primer rated for 325°F. A finish top coat may be applied in the field. Other coating options are available upon request. Brackets and other mounting options are also available. Please note all side inlet designs have dual drains. Contact your Dürr Universal rep for updated drawing.

Typical Attenuation Curve

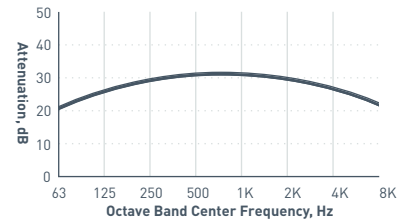

TECHNICAL PRESENTATION

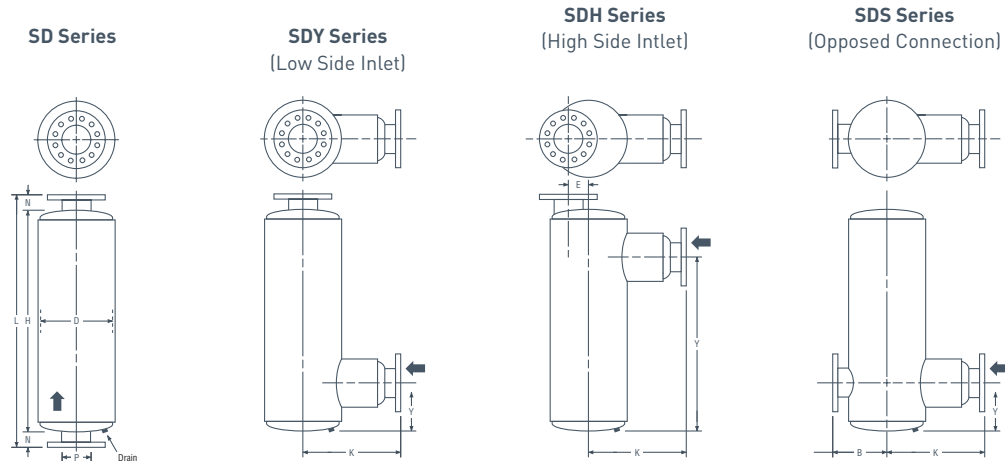

COMBINATION CHAMBER-ABSORPTIVE TYPE DISCHARGE SILENCERS

P (Size)	Part Number	D	L	N	H	K			B	E	SDY		Y SDS		SDH		Weight	
						SDY	SDH	SDS			Min	Max	Min	Max	Min	Max		
1	Sizes 1" - 1 1/2" use URB Series (page 15)																	
1 1/2																		
2	54-102-AA	8	28 1/2	3	22 1/2	8 1/2	—	—	—	—	—	—	—	—	—	—	—	15
2 1/2	54-125-AA	8	33	3	27	9	—	—	—	—	—	—	—	—	—	—	—	25
3	54-103-AA	8	39	3	33	10	—	—	—	—	—	—	—	—	—	—	—	30
3 1/2	54-135-AA	10	39 1/2	3	33 1/2	11	—	—	—	—	—	—	—	—	—	—	—	40
4	54-104-AA*	10	45	3	39	12 1/2	14 1/2	14 1/2	8	2 1/4	7 1/2	16 1/2	7 1/2	9 1/2	30 1/2	32 1/2	50	
5	54-105-AA*	12	57 1/2	3	51 1/2	15 1/2	17 1/2	17 1/2	9	2 3/4	9	23	9	12 1/2	40	43 1/2	80	
6	54-106-AA	14	64	3	58	17	20	20	10	3 1/4	9	25 1/2	10	15 1/2	43 1/2	49	110	
8	54-108-AA	18	72	3 1/2	65	21 1/2	26 1/2	26 1/2	12 1/2	4	12	30 1/2	12	16 1/2	49 1/2	54	190	
10	54-110-AA	22	85	3 1/2	78	25 1/2	32 1/2	32 1/2	14 1/2	5	13 1/2	37	13 1/2	18	61 1/2	65 1/2	380	
12	54-112-AA	26	98	3 1/2	91	29 1/2	38	38	16 1/2	6	15	44	15	24	69	77	550	
14	54-114-AA	30	111	3 1/2	104	30	40	40	18 1/2	7 1/2	16 1/2	50	16 1/2	25	81	89 1/2	800	

Acoustical packing is suitable up to 325°F

For silencers with connections larger than 14" please contact Dürr Universal for price and availability.

Note: Dimensions (in) and weights (lbs) are nominal and may vary slightly with production models. Request certified drawings of specific models for exact dimensions.

*Specify -TT for male pipe threaded units.

Specifications RD Group

Combination Chamber-Absorptive Type Discharge Silencer

The RD Series Discharge Silencer is a heavy-duty, all-welded unit offering premium attenuation. Silencers are constructed of carbon steel, designed to provide long service life. The RD Series is designed for maximum pulse control and silencing for the most demanding Critical PLV Applications.

Silencers are designed for either vertical or horizontal mounting. Designs will allow for low or high side inlets for mounting flexibility. A low side inlet version is designated as RDY Series, and the high side inlet configuration is designated as RDH Series. The opposed connection version is designated as the RDS Series. All versions have identical performance characteristics.

Silencers with connection sizes of 3-1/2" and smaller are offered with male NPT threaded connections. Silencers with connection sizes of 4" and 5" are available with either NPT male threads, or flanges. Silencer connections of 6" and above are provided with 125/150# ANSI Drilled Plate Flanges. The standard primer paint applied to exterior surfaces is a single-coat satin light blue alkyd primer rated for 325°F. A finish top coat may be applied in the field. Other coating options are available upon request. Brackets and other mounting options are also available. Please note all side inlet designs have dual drains. Contact your Dürr Universal rep for updated drawing.

Typical Attenuation Curve

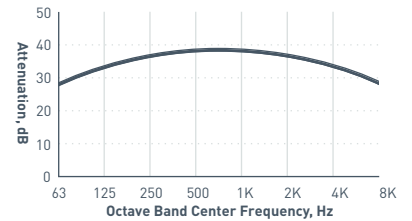

TECHNICAL PRESENTATION

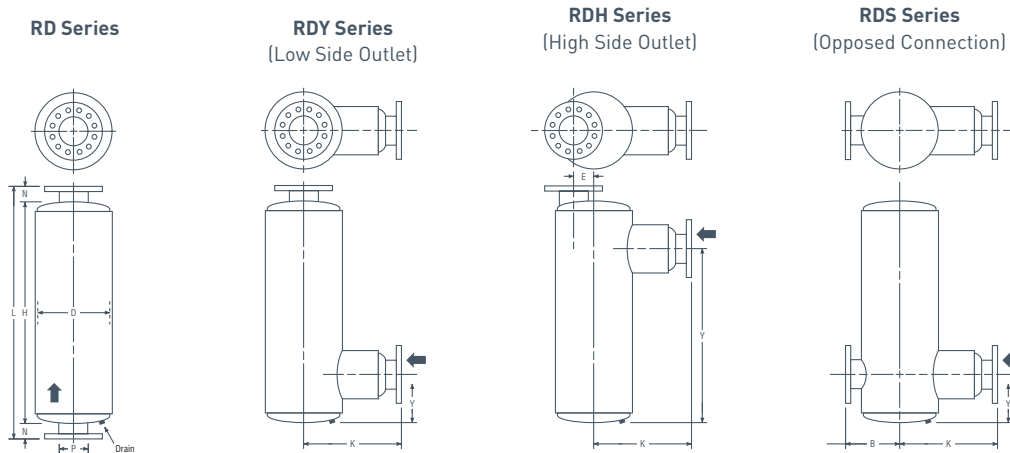

COMBINATION CHAMBER-ABSORPTIVE TYPE DISCHARGE SILENCERS

P (Size)	Part Number	D	L	N	H	K			B	E	RDY		Y RDS		RDH		Weight
						RDY	RDH	RDS			Min	Max	Min	Max	Min	Max	
1	Sizes 1"-1½" use URB Series (page 15) or use U5 Series: (page 27)																
1½																	
2	57-102-AA	8	33	3	27	9	—	—	—	—	FIXED AT 6	—	—	—	—	—	25
2½	57-125-AA	10	34	3	28	10	—	—	—	—	FIXED AT 7	—	—	—	—	—	35
3	57-103-AA	10	43	3	40	10	—	—	—	—	FIXED AT 7	—	—	—	—	—	40
3½	57-135-AA	12	52	3	46	11	—	—	—	—	FIXED AT 8	—	—	—	—	—	60
4	57-104-AA*	14	53	3	47	14½	16	14½	10	4	8	20	8	14	33	39	80
5	57-105-AA*	16	65	3	59	16½	18	16½	11	4½	9	26½	9	16½	43½	51	130
6	57-106-AA	18	72	3	66	20½	22½	20½	12	5	10	30	10	20	46	56	160
8	57-108-AA	22	97	3½	90	24½	28½	26	14½	6	12	45	12	26	65	79	410
10	57-110-AA	26	122	3½	115	28½	34	32	16½	7	14	60½	14	37½	79½	103	600
12	57-112-AA	30	135	3½	128	35	42	39½	18½	8	15½	66	15½	39	91	114½	900
14	57-114-AA	36	161	3½	154	40½	47½	45½	21½	10½	17½	78	17½	46	110	138	1,400

Acoustical packing is suitable up to 325°F

For connection sizes above 14" please contact Dürr Universal for price and availability.

Note: Dimensions (in) and weights (lbs) are nominal and may vary slightly with production models. Request certified drawings of specific models for exact dimensions.

*Specify -TT for male pipe threaded units.

Specifications SURS Group

Chamber Type Multi-Use Silencer

SURS Series blower silencers are heavy-duty, all-welded steel construction, suitable for either inlet or discharge applications. The SURS series is designed for application to blowers operating above critical transition speed. As a result, there is no acoustical packing in these silencers. These silencers incorporate a unique high performance, three chamber system which utilizes a diffuser on the blower side of the silencer. The SURS Series provides excellent pulse control, and is designed for the most demanding conditions, in particular for applications that do not utilize any acoustical packing material.

Connection sizes smaller than 4" are provided with standard NPT male pipe nipples. Silencers with connection sizes of 4" and larger have 125/150# ANSI drilled plate flanges.

The SURS is a basic end-in, end-out configuration. A low side inlet version is available as the SURSY Series. Both the SURS and SURSY versions are similar in gas flow path offering identical performance.

The SURS and SURSY Series silencers exterior surfaces are coated with a single-coat aluminum paint rated for 1000°F. Other paint systems are available upon request. Please note all side inlet designs have dual drains. Contact your Dürr Universal rep for updated drawing.

Typical Attenuation Curve

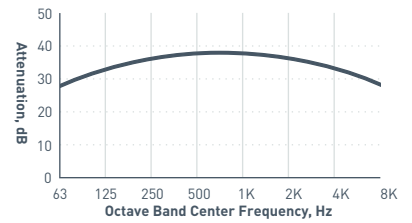

TECHNICAL PRESENTATION

SURS Series

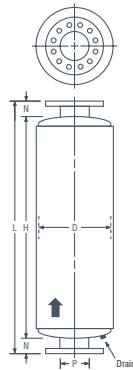

SURSY Series
(Low Side Inlet)

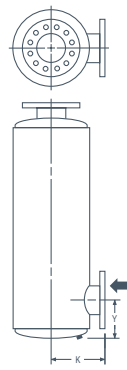

COMBINATION CHAMBER TYPE MULTI-USE DISCHARGE SILENCERS

SURS		SURSY		P	D	L	N	H	K	Y		Weight
Model	Part	Model	Part							Min.	Max	
SURS-2	55-A02-SS	SURSY-2	55-B02-SS	2	12	40	3	34	9	4½	13	55
SURS-2.5	55-A25-SS	SURSY-2.5	55-B25-SS	2½	12	40	3	34	9	4½	13	55
SURS-3	55-A03-SS	SURSY-3	55-B03-SS	3	12	46	3	40	9	5	15	60
SURS-3.5	55-A35-SS	SURSY-3.5	55-B35-SS	3½	14	59	3	53	10	5½	20	90
SURS-4	55-A04-SS*	SURSY-4	55-B04-SS*	4	14*	59	3	53	10	6	20	100
SURS-5	55-A05-SS*	SURSY-5	55-B05-SS*	5	16*	71	3	65	11	7	25	160
SURS-6	55-A06-SS	SURSY-6	55-B06-SS	6	18	72	3	66	12	8	25	200
SURS-8	55-A08-SS	SURSY-8	55-B08-SS	8	26	111	3½	104	16½	10	41	520
SURS-10	55-A10-SS	SURSY-10	55-B10-SS	10	30	136	3½	129	18½	12	51	810
SURS-12	55-A12-SS	SURSY-12	55-B12-SS	12	36	138	3½	131	21½	14	50	1,130
SURS-14	55-A14-SS	SURSY-14	55-B14-SS	14	36	168	3½	161	21½	16	63	1,400

For silencer connections above 14" please contact Dürr Universal for price and availability.

Note: Dimensions (in) and weights (lbs) are nominal and may vary slightly with production models. Request certified drawings of specific models for exact dimensions.

*Specify -TT for male pipe threaded units.

Accessories and Optional Features

UCI, RIS, UCD, URB, URD, SD, RD, and SURS Blower Silencers

In addition to the standard accessories shown here, other special features such as special materials and finishes will be quoted on request. Standard material is Carbon Steel, but typical special materials include 304, 304L, 316, and 316L stainless. Contact Dürr Universal with your specific requirements.

TECHNICAL PRESENTATION

MOUNTING BRACKETS

Mounting Brackets or legs are available for any of the silencers in this section. Saddle type brackets for horizontal mount and angle legs for vertical mount are typical accessories. Special design brackets will be quoted with your specifications.

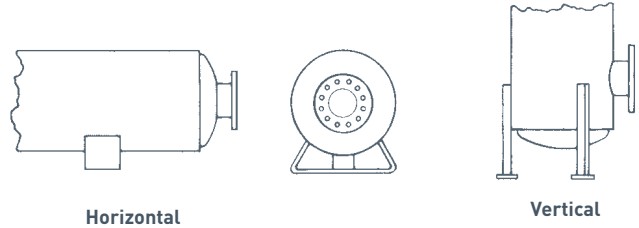

PRESSURE VESSEL CONSTRUCTION

All silencers shown in this catalog can be fabricated in accordance with Div. 1, Section VIII—ASME Code for Unfired Pressure Vessels. Dimensions are similar to standard models, but material types and thicknesses are selected to meet code requirements. Prices are quoted on application to meet your pressure and temperature conditions.



INSPECTION OPENINGS

Inspection Openings with bolted and gasketed cover plates are available installed at the time the silencer is fabricated. They are designed to withstand the usual range of pressure encountered with blowers. One inspection opening is usually installed in each silencer chamber for cleaning or inspection. Standard sizes include: 3"x4", 4"x6", 6"x8".

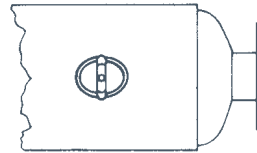

OVERSIZE FLANGES

Frequently the blower flange size is larger than the required silencer's connection. Rather than use a larger silencer, it is usually more economical to use an oversize reducing flange on the silencer. This is the conventional piping practice and may be used on either inlet or discharge silencers. Example: a 10" flange size silencer has adequate capacity for a blower with a 12" discharge flange. A flange having a drilling pattern to match the 12" blower flange but with a 10" bore to match the silencer nozzle is substituted on the silencer blower connection.

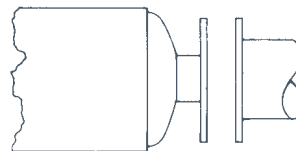

Two pipe sizes (e.g., 10" to 14") is the recommended maximum variation. Prices on request.

CB Series

Compact Blower Silencer

The Dürr Universal CB Series of compact blower silencers are smaller in size when compared to other more conventional styles of blower silencers. The CB Series is used when space is at a premium. These silencers are designed to provide intake or discharge silencing on rotary positive blowers. On average, the CB Series Silencers are about 1/3 the size of conventional silencers, providing savings in cost and weight.

The CB Series silencers utilize an absorptive internal pack suitable for temperatures up to 325°F, and pressures up to 15 psig. Flanged or threaded connections are available. The standard primer paint applied to exterior surfaces is a single-coat satin light blue alkyd primer rated for 325°F. A finish top coat may be applied in the field.

Typical Attenuation Curve

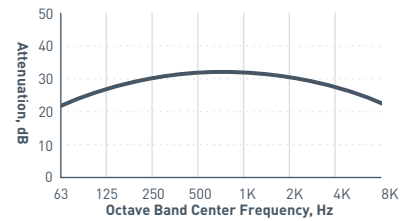

TECHNICAL PRESENTATION

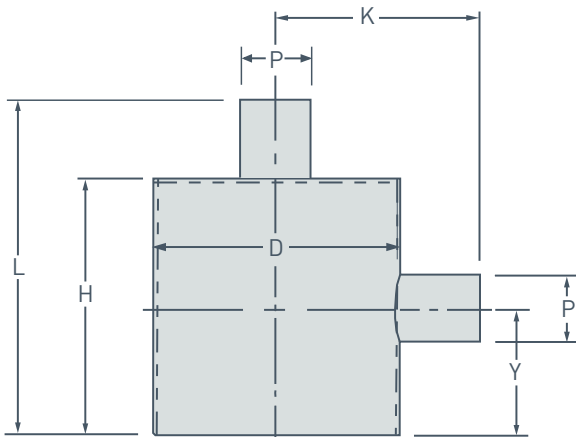

Pressure Drop Curves

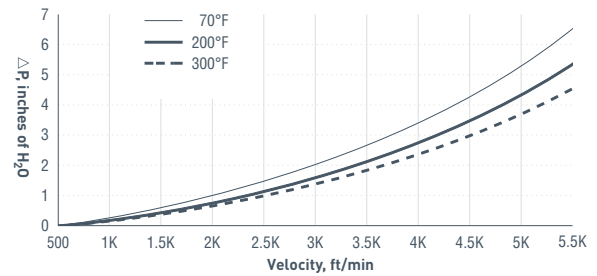

COMPACT BLOWER SILENCERS

Model	Part Number	P (nom.)	D	L	H	Y	K	Weight	CFM CAP
CB-2	56-702-AA	2	8	11	8	4	7	15	120
CB-2½	56-725-AA	2½	8	12½	9½	4¾	7	25	187
CB-3	56-703-AA	3	12	13½	10½	5¼	9	35	270
CB-4	56-704-AA	4	12	18	15	7½	9	45	480
CB-5	56-705-AA	5	16	20	17	8½	11	70	750
CB-6	56-706-AA	6	16	26	23	11½	11	85	1,080
CB-8	56-708-AA	8	24	31	27½	13¾	15½	170	1,920
CB-10	56-710-AA	10	30	39	35½	17¾	18½	275	3,000
CB-12	56-712-AA	12	34	43	39½	19¾	20½	355	4,320

Note: Dimensions (in) and weights (lbs) are nominal and may vary slightly with production models. Request certified drawings of specific models for exact dimensions.

CBF/CBFI Series

Compact Blower Inlet Filter-Silencer

Filter and silencer combined in one unit. The CBF and CBFI have the acoustic capabilities of the Dürr Universal RIS Series silencers and the filtration performance of CC series filters.

Reduced cost, overall package size, weight, storage space, freight cost, and damage.

Approximately one third the size of conventional blower silencer, with the added benefit of excellent, high-efficiency filtration.

Reduced overall package noise without further acoustic treatment.

Versatile—Suitable for inlet applications in confined areas, outdoor or indoor, without compromising acoustic or pressure drop performance. The standard topcoat paint applied is a single-coat semigloss light blue alkyd enamel rated for 300°F. For outdoor applications: The standard two coat paint system applied is a single coat alkyd primer with a single-coat semigloss light blue alkyd enamel topcoat with a temperature rating of 300°F. See page 73 for paper/felt/wire temperature ratings.

Typical Attenuation Curve

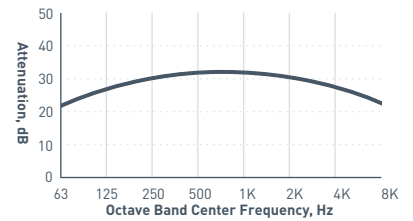

TECHNICAL PRESENTATION

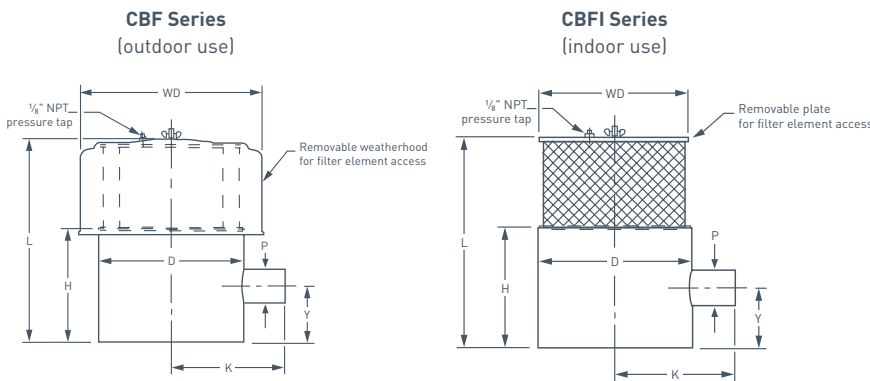

P (nom.)	Element Part Number		
	Paper	Felt	Wire
2	81-0471*	81-1203*	81-1036*
2½	81-0471*	81-1203*	81-1036*
3	81-1063	81-1205	81-1038
4	81-1063	81-1205	81-1038
5	81-0475	81-1207	81-1040
6	81-0475	81-1207	81-1040
8	81-1163	81-1209	81-1200
10	81-1163	81-1209	81-1200
12	81-1164	81-1210	81-1201

MODELS, DIMENSIONS, WEIGHTS, AND ELEMENTS

P (nom.)	CBF/CBFI					CFM CAP	Part	CBF			CBFI		
	D	H	Y	K	WD			L	Weight	Part	B	L ₁	Weight
2	8	8	4	7	120	34-702-AA	10	13¼	20	34-G02-AA	6½	12¾	20
2½	8	9	4¾	7	175	34-725-AA	10	14¾	25	34-G25-AA	6½	14¼	25
3	12	10	5¼	9	275	34-703-AA	16	17	50	34-G03-AA	10	16½	50
4	12	15	7½	9	500	34-704-AA	16	21¼	60	34-G04-AA	10	20¾	60
5	16	17	8½	11	750	34-705-AA	20	26	85	34-G05-AA	12	25¼	85
6	16	23	11½	11	1,100	34-706-AA	20	32	100	34-G06-AA	12	31¼	100
8	24	24½	13¾	15½	2,200	34-708-AA	30	39	200	34-G08-AA	12	39¼	185
10	30	35½	17¾	18½	3,000	34-710-AA	36	46½	305	34-G10-AA	18	45¾	295
12	34	39½	19¾	20½	4,300	34-712-AA	40	54½	385	34-G12-AA	24	53¾	370

Non-ASME Code construction suitable for 15" Hg vacuum. Weights are approximate and do not include the weight of the filter element.

Note: Dimensions (in) and weights (lbs) are nominal and may vary slightly with production models. Request certified drawings of specific models for exact dimensions.

*Pair of elements required (stacked).

UNI-BASE Plates/Components

Rotary Positive Blowers

These base plate products accommodate a variety of blower package designs. The UNI-BASE package and the UNI-BASE base plate use the same basic base plate and discharge silencer. The UNI-BASE package includes the Dürr Universal model URBN high-side inlet silencer and CCF inlet air filter, while the UNI-BASE base plate is only the basic plate and the URBV discharge silencer. Please see page 15 for performance and sizing information for the URBV series silencers, page 23 for information on the URBN series silencers, and page 72 for performance data, weights, and dimensions of CCF filters. Custom UNI-BASE base plates can be made for most of our blower silencers. Please contact us for quote. Please contact us for other series options.

TECHNICAL PRESENTATION

UNI-BASE Package

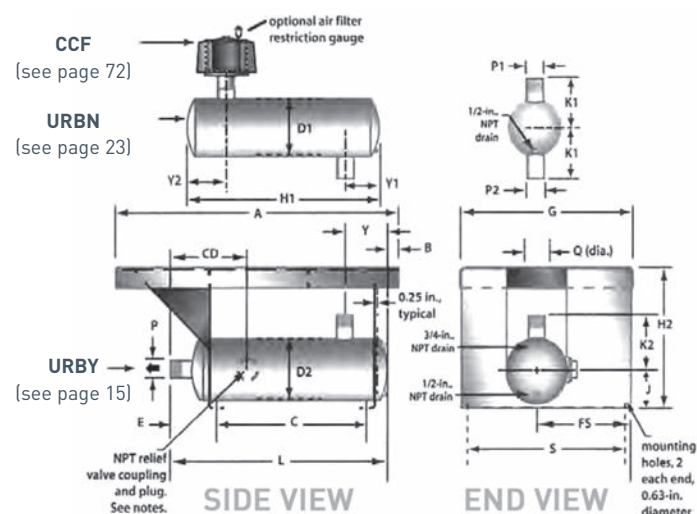

UNI-BASE Base Plate Only

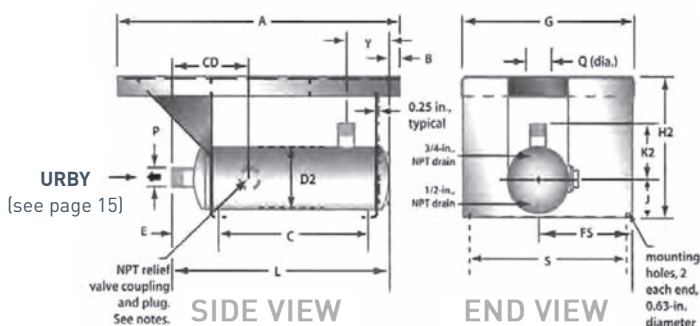

MODELS, DIMENSIONS, WEIGHTS AND ELEMENTS

Size	Package	Base Plate Only	URBN Only	URBV Only	CCF Only
2	80-1873	55-202-ABP	55-502-AA	55-202-AA	34-L02-TT*
2½	80-1874	55-225-ABP	55-525-AA	55-225-AA	34-L25-TT*
3	80-1875	55-203-ABP	55-503-AA	55-203-AA	34-L03-TT*
4	80-1876	55-204-ABP	55-504-AA	55-204-AA	34-L04-TT*
5	80-1877	55-205-ABP	55-505-AA	55-205-AA	34-L05-TT*
6	80-1878	55-206-ABP	55-506-AA	55-206-AA	34-L06-TT*

Note: Dimensions (in) and weights (lbs) are nominal and may vary slightly with production models. Request certified drawings of specific models for exact dimensions.

*Specify "P" at end of part number for unit with pleated paper elements, "F" for pleated felt or "W" for wire mesh.

Refer to page 70 for filter element details.

DIMENSIONS AND WEIGHTS

UNI-BASE BASE PLATE (W/URBY)

P (nom.)	A	B	C	CD	D2	E	FS	G	H2	J	K2	L	Q (Dia.)	S	Y	Approx. Weight
2	39	1½	20¾	10¾	8	6½	13	23½	16	5	7	30	3½	21	6	125
2½	44½	1½	21	11¼	10	6¾	14¼	27½	17	6	8	31	4	25	7	170
3	55½	4	31½	12	10	7½	15¼	29¾	17	6	8	43	4¾	26¼	7	270
4	56	—	37½	15½	14	8	16½	33	24½	8	10	50	6	29¾	11	355
5	66	—	43½	18¼	16	13¾	14¾	35	23½	9	11	62½	11	30½	12	500
6	66	—	52	18¼	18	10½	15¼	35¼	26½	10¼	12	69	12	30½	12	645

Note: 1. Sizes 2"–3" URBY discharge silencers are shipped standard with male pipe threaded connections. 4" and 5" URBY discharge silencers are shipped standard with male pipe threaded discharge connections and plain pipe blower connections. 6" URBY discharge silencers are shipped standard with flanged discharge connection drilled to 125/152 lb. ANSI specifications and plain pipe blower connections.

2. Sizes 2"–3" URBY discharge silencers have a 2" NPT relief valve coupling and plug. Sizes 4"–6" URBY discharge silencers have a 3" NPT relief valve coupling and plug.

3. UNI-BASE base plate kit sizes 2"–4" require gussets.

Dimensions (in) and weights (lbs) are nominal and may vary slightly with production models. Request certified drawings of specific models for exact dimensions.

URBN SILENCERS

P1/P2 (nom.)	D1	H1	K1	Y1	Y2	Approx. Weight
2	8	27	7	6	3½	25
2½	10	28	8	7	4½	35
3	10	40	8	7	4½	50
4	14	47	10	6	5½	80
5	16	60	11	6	6½	140
6	18	66	12	8	7½	170

Note: 1. Sizes 2"–4" URBN inlet silencers are shipped with male pipe threaded inlets and plain pipe outlets. Sizes 5" and 6" URBN inlet silencers are shipped standard with flanged inlet connections drilled to 125/150 lb ANSI specifications and plain pipe outlets.

Dimensions (in) and weights (lbs) are nominal and may vary slightly with production models. Request certified drawings of specific models for exact dimensions.

CCF Silencers (please see page 72)



03

Absorptive Silencers

U5 Series	_____	27
U2 Series	_____	28
SU Series	_____	29

Absorptive Silencers

The absorptive type silencer is the classic dissipative design that absorbs noise energy by the use of various types of fibrous packing materials. As sound waves pass through the spaces between the tightly packed small diameter pack fibers, the resulting viscous friction dissipates the sound energy as small amounts of heat.

Absorptive silencers are very effective on high frequency noise (500-8,000 Hz). At frequencies above and below this range, attenuation is somewhat diminished. Since noise is absorbed by the packing material, absorptive silencers do not rely on internal baffles, tubes, or chambers to achieve noise reduction. As a result absorptive silencers generally utilize a "straight-through" gas flow path that minimizes flow restriction.

Dürr Universal Absorptive Series of silencers are listed below.

U5 SERIES

Premium grade straight-through silencer available in pipe sizes of ½" to 6". Attenuation is similar to the SU5 Series.

U2 SERIES

Standard grade straight-through silencer available in pipe sizes 5" to 16". For better performance use SU5, SU4, or SU3 series.

SU5 SERIES

Premium grade full-flow annular type silencer available in pipe sizes of 4" to 30".

SU4 SERIES

Annular type silencer available in pipe sizes 8" to 60" providing enhanced performance over SU3 series.

SU3 SERIES

Standard grade annular type silencer with performance one grade below the SU4 Series. The SU3 Series is available in pipe sizes 8" to 30". For enhanced performance, use SU4 or SU5 series.

SIZING INFORMATION, PRESSURE DROP DATA

The flow area through the silencer must be sufficient to accommodate the maximum flow without imposing excessive pressure drop. The following instructions enable the selection of the proper silencer size and determination of actual pressure drop. These instructions assume air as the flowing gas. For other gases, density and other corrections may be necessary—contact Dürr Universal for assistance.

Data required:

- air flow rate (actual CFM)
- temperature (°F)
- pressure (psig)
- maximum allowable pressure drop (inches of water)

1 Determine maximum velocity.

$$V = 4005 \sqrt{\left(\frac{\Delta P}{c}\right) \left(\frac{14.7}{P+14.7}\right) \left(\frac{T+460}{530}\right)}$$

V = air or gas velocity, ft/min (see note 1)

ΔP = maximum pressure drop, inches of water

c = silencer pressure drop coefficient (see Table 1)

T = air temperature, °F (see note 2)

P = operating pressure, psig (If at atmospheric pressure, pressure ratio is unity and may be omitted from equation. If P exceeds 15 psig, contact Dürr Universal for recommendations.)

2 Determine flow area required.

$$A = \frac{Q}{V}$$

A = flow area required, ft²

Q = air flow rate (actual CFM)

$$\text{Actual CFM} = (\text{Standard CFM}) \left(\frac{14.7}{P+14.7}\right) \left(\frac{T+460}{530}\right)$$

3 From Table 2, select size with flow area equal to or greater than that calculated.

4 Determine actual gas velocity in feet per minute.

$$V_{\text{actual}} = \frac{Q}{A}$$

A = flow area from Table 2

5 Determine actual pressure drop.

$$\Delta P = c \left(\frac{V_{\text{actual}}}{4005}\right)^2 \left(\frac{530}{T+460}\right) \left(\frac{P+14.7}{14.7}\right)$$

c = silencer pressure drop coefficient (see Table 1)

1 PRESSURE DROP COEFFICIENTS

Silencer Series	Pressure Drop Coefficient (C)
U5, U2	.25
SU5	.75
SU3, SU4	.85

2 FLOW AREA SIZE

Diameter Size (in)	Flow Area (ft ²)	Diameter Size (in)	Flow Area (ft ²)
½	0.0014	22	2.6
¾	0.0031	24	3.1
1	0.0055	26	3.7
1½	0.012	28	4.3
2	0.022	30	4.9
2½	0.034	32	5.6
3	0.049	34	6.3
3½	0.067	36	7.1
4	0.087	38	7.9
5	0.136	40	8.7
6	0.196	42	9.6
8	0.349	44	10.6
10	0.55	46	11.5
12	0.79	48	12.6
14	1.07	54	15.9
16	1.4	60	19.6
18	1.8	66	23.8
20	2.2	72	28.3

Note:

1. Because "self noise" and aerodynamic noise increase with velocity, absorptive silencers are usually sized for 4,000 to 8,000 ft/min. In no case should the velocity exceed 15,000 ft/min regardless of pressure drop allowed.
2. Typical attenuation curves indicate the characteristics of the silencer series and are neither a minimum nor a guarantee for an individual silencer. Individual silencer performance can be affected by sound source characteristics including pure tones, flow velocity, adjacent piping, and temperature.

U5 Series

Straight-Through Absorptive Silencer

The U5 Series is a premium grade straight-through absorptive silencer which provides excellent noise attenuation due to its high length to diameter ratio. It is especially well suited for inlet applications on small rotary positive, or centrifugal blowers, or discharge of vacuum pumps. The U5 Series consists of mild steel construction and is painted with a standard single-coat semigloss light blue alkyd enamel rated for 300°F.

Common Applications

- Rotary positive/centrifugal blowers
- Vacuum pump discharge
- Air valves and cylinders
- Small low-pressure vents
- High-frequency noise sources

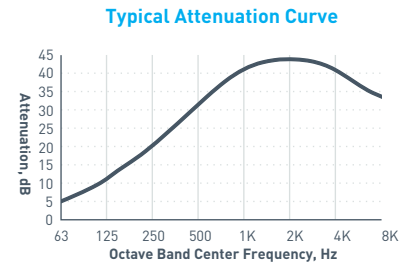

TECHNICAL PRESENTATION

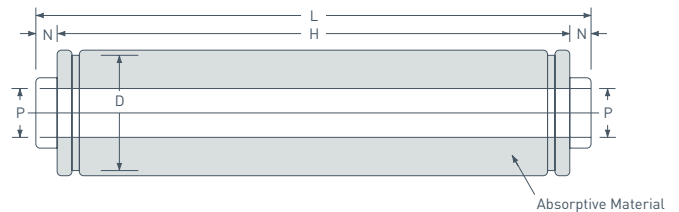
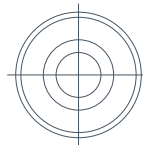

Sizes 1/2" through 4" utilize female NPT pipe connections.
 Sizes 5" and 6" utilize 125/150# ANSI drilled plate flanges.

Note: U5 series acoustical packing is suitable for 325°F.

STRAIGHT-THROUGH ABSORPTIVE SILENCER

Model	Part	P	D	L	N	H	Weight
U5-1/2	11-150-AA	1/2	3 1/4	8	—	—	2
U5-3/4	11-170-AA	3/4	3 1/4	11	—	—	3
U5-1	11-101-AA	1	3 1/4	14	—	—	3
U5-1 1/4	11-121-AA	1 1/4	3 1/4	16	—	—	4
U5-1 1/2	11-115-AA	1 1/2	4 1/4	19 3/4	—	—	6
U5-2	11-102-AA	2	5 1/8	26	—	—	10
U5-2 1/2	11-125-AA	2 1/2	6 1/8	33 1/2	—	—	15
U5-3	11-103-AA	3	6 5/8	36 1/2	—	—	20
U5-4	11-104-AA	4	8	48 7/8	—	—	40
U5-5	11-105-AA	5	10	57	3	—	60
U5-6	11-106-AA	6	12	63	3	—	100

Note: Dimensions (in) and weights (lbs) are nominal and may vary slightly with production models. Request certified drawings of specific models for exact dimensions.

U2 Series

Straight-Through Absorptive Silencer

The U2 Series is a standard grade straight-through absorptive silencer. The U2 Series utilizes a lower length to diameter ratio. The U2 Series consists of mild steel construction and is painted with a standard single-coat semigloss light blue alkyd enamel rated for 300°F.

Common Applications

- Intermediate size rotary positive blower inlet
- Centrifugal blower inlet or discharge
- Intermediate size dry vacuum pump discharge
- Gas turbine inlet
- High-speed centrifugal compressor inlet
- High-frequency noise sources

Typical Attenuation Curve

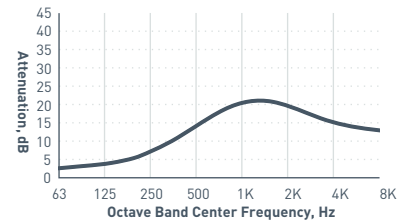

TECHNICAL PRESENTATION

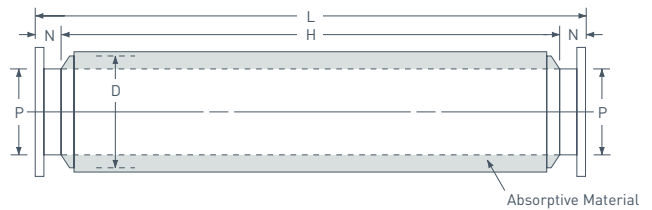
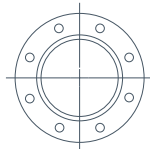

All sizes utilize 125/150# ANSI drilled plate flanges.

Note: U2 series acoustical packing is suitable for 325°F.

STRAIGHT-THROUGH ABSORPTIVE SILENCER

Model	Part	P	D	L	N	H	Weight
U2-5	10-105-AA	5	10	36	3	30	45
U2-6	10-106-AA	6	12	40	3	34	70
U2-8	10-108-AA	8	14	53	3½	46	105
U2-10	10-110-AA	10	16	65	3½	58	160
U2-12	10-112-AA	12	18	77	3½	70	220
U2-14	10-114-AA	14	20	89	3½	82	340
U2-16	10-116-AA	16	22	101	3½	94	440

For inlet sizes above 16" please contact Dürr Universal for price and availability.

Note: Dimensions (in) and weights (lbs) are nominal and may vary slightly with production models. Request certified drawings of specific models for exact dimensions.

SU Series

Annular Flow Absorptive Silencer

SU3, SU4, and SU5 Series silencers are available in sizes from 4" through 30" inlets. For sizes larger than 30" please contact Dürr Universal for price and availability. The paint applied is a single-coat semigloss light blue alkyd enamel rated for 300°F.

Common Applications

- Inlet and discharge of high-speed low-pressure centrifugal compressors and blowers less than 15 psig
- Industrial fan inlet and discharge
- High-pressure centrifugal compressors inlet
- Gas turbine inlet
- Dry vacuum pump discharge
- Some low-pressure vents less than 15 psig
- High-frequency noise sources
- Inlet of turbocharged reciprocating engines

TECHNICAL PRESENTATION

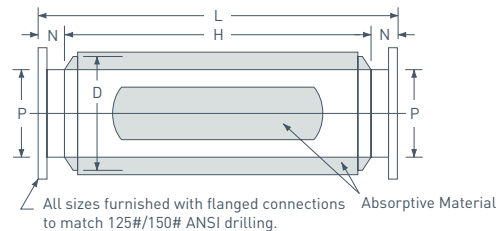
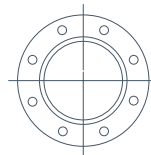

Note: SU Series standard paint and acoustical packing are suitable for 325°F.

SU5 SERIES

The SU5 Series is a premium grade annular flow absorptive silencer. The design consists of two concentric perforated cylinders lined with acoustical packing. The two concentric cylinders form an annular flow path with blocked line of sight providing full flow area for low resistance.

SU4 SERIES

The SU4 Series provides lower intermediate attenuation, ranking just below the SU5 Series. The design of this unit features a bullet centered in the flow tube to provide annular flow path and partial blocked line of sight. Pressure drop is only slightly greater than the SU5.

SU3 SERIES

The SU3 Series is a standard grade annular flow absorptive silencer. The design is nearly identical to the SU4, including annular flow path and partial blocked line of sight. Pressure drop is same as the SU4.

SU Series

Annular Flow Absorptive Silencer

Typical Attenuation Curve
SU5 Series

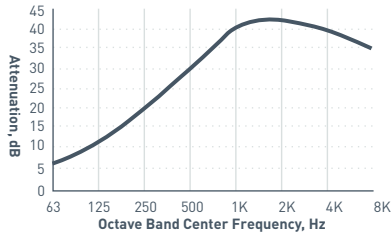

Typical Attenuation Curve
SU4 Series

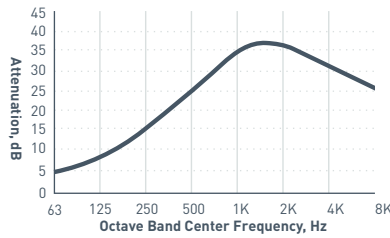

Typical Attenuation Curve
SU3 Series

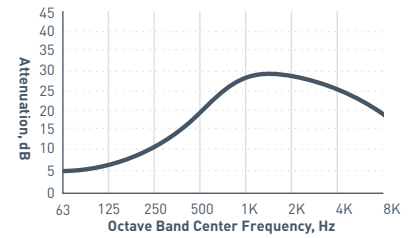

ANNUAL FLOW ABSORPTIVE SILENCER

Model	Part	P	D	L	N	H	Weight
SU5-4	14-104-AA	4	10	21½	3	15½	30
SU5-5	14-105-AA	5	12	26	3	20	55
SU5-6	14-106-AA	6	12	26	3	20	60
SU5-8	14-108-AA	8	18	36	3½	29	120
SU5-10	14-110-AA	10	20	44½	3½	37½	195
SU5-12	14-112-AA	12	24	53	3½	46	290
SU5-14	14-114-AA	14	26	61½	3½	54½	390
SU5-16	14-116-AA	16	28	68	3½	61	500
SU5-18	14-118-AA	18	30	74	3½	67	650
SU5-20	14-120-AA	20	36	78	4½	69	950
SU5-22	14-122-AA	22	36	89	4½	80	1,080
SU5-24	14-124-AA	24	42	91	4½	82	1,400
SU5-26	14-126-AA	26	42	102	4½	93	1,580
SU5-28	14-128-AA	28	48	104	4½	95	2,200
SU5-30	14-130-AA	30	48	115	4½	106	2,600
SU4-8	13-108-AA	8	14	33	3½	26	90
SU4-10	13-110-AA	10	16	35	3½	28	120
SU4-12	13-112-AA	12	18	47	3½	40	180
SU4-14	13-114-AA	14	20	51	3½	44	240
SU4-16	13-116-AA	16	22	59	3½	52	320
SU4-18	13-118-AA	18	24	63	3½	56	370
SU4-20	13-120-AA	20	26	73½	4½	64½	490
SU4-22	13-122-AA	22	28	73½	4½	64½	530
SU4-24	13-124-AA	24	30	85½	4½	76½	720
SU4-30	13-130-AA	30	36	108	4½	99	1,340
SU3-8	12-108-AA	8	14	31	3½	24	85
SU3-10	12-110-AA	10	16	35	3½	28	120
SU3-12	12-112-AA	12	18	39	3½	32	155
SU3-14	12-114-AA	14	20	39	3½	32	200
SU3-16	12-116-AA	16	22	47	3½	40	270
SU3-18	12-118-AA	18	24	47	3½	40	290
SU3-20	12-120-AA	20	26	49½	4½	40½	350
SU3-22	12-122-AA	22	28	55½	4½	46½	420
SU3-24	12-124-AA	24	30	55½	4½	46½	500
SU3-26	12-126-AA	26	30	61	4½	52	680
SU3-28	12-128-AA	28	36	63½	4½	54½	830
SU3-30	12-130-AA	30	36	62	4½	53	890

Note: Dimensions (in) and weights (lbs) are nominal and may vary slightly with production models. Request certified drawings of specific models for exact dimensions.

04

Vent Silencers

HV Series _____	32
Application Methodology _____	33
Product Description _____	34

HV Series

Combination Vent Silencers

Vent and blowdown silencers are rarely a simple catalog selection. For each application, detailed specifications and system description are required for Dürr Universal to provide a custom solution. By providing either a valve manufacturer's specification sheet, or a vent silencer application sheet, our experienced sales and application engineering staff can provide a silencer best suited to meet your application requirements.

TECHNICAL PRESENTATION

VERSATILE SILENCERS

Dürr Universal HV Series vent silencers effectively silence high velocity air, steam, gas vents, and blowdown to atmosphere where sonic, or critical conditions exist in the valve. Typical applications include:

- Steam boiler relief valves
- Superheater header relief valves
- Boiler startup and purge
- High-pressure air vents
- Natural gas blowdowns
- Switch valves
- Compressor blowoffs
- Autoclaves
- Steam ejectors

STANDARD FEATURES

- Inlet plenum covered with outer acoustic wrap and lag shell to reduce outer mechanically induced shell noise, and internal flow noise.
- Highly absorptive acoustic fill material, and heavy gauge perforated face sheets for exceptional attenuation at high frequencies.
- Inlet nozzle and diffuser with flanged connections are provided with 150# raised face flanges. Other styles of inlet connections can be provided to meet application requirements.
- Lifting lugs provided for simple installation.
- A bottom drain is provided to eliminate water accumulation.
- HV series silencers standard paint is a single coat aluminum rated for 1000°F. Alternate surface preparation and exterior coatings can be provided to meet specific requirements.
- Silencers can be provided for either vertical or horizontal applications.

OPTIONAL FEATURES

- Construction options using alternate materials, such as stainless steel, Monel, or other types can be provided to meet special application requirements.
- Mounting brackets and other special supports to provide ease of installation.
- Outlet heads and nozzles can be provided for inline applications.
- Restrictive diffusers built to ASME Section VIII Division 1, designed to maintain back pressure or control blowdown time.
- Elbows, tailpipes, and weather hoods are available.
- Special paints.
- Side inlets available.
- Optional floating inlet providing 2" axial and +/-1" lateral movements or axial only.

Annular Ring



Acousti-Tube™



High-Efficiency
Acoustic Pack

Designed for
Optimum Space
Considerations

All-Welded Steel
Outer Shell

Pack Retention with
Pre-Compression

Lower Chamber
Insulation
(Except HV5
and HV10)

Inlet Diffuser,
Depending on
Application

The concentric annular ring design (left) and the wrapped Acousti-Tube vent silencer design (right) offer a choice of silencer profile and configuration to meet site-specific requirements.

A COMPLETE SOLUTION

Dürr Universal's extensive in-house engineering, testing, and manufacturing facilities with optimized processes will provide both mechanical and acoustic solutions for any application.

Application Methodology

Vent Silencers

The Dürr Universal HV Series of vent and blowdown silencers come with an inlet diffuser that is a critical element to the acoustic and mechanical performance. Both the inlet nozzle and the diffuser are designed and constructed to withstand thermal and impact stresses produced in high pressure, high temperature, continuous or intermittent blowdown service.

In vent applications, critical flow will occur for most gases at valve upstream pressures greater than twice the outlet pressure. Vent and blowdown noise levels increase with increased pressure drop and are also affected by valve aerodynamic recovery characteristics. Large valve, low-pressure vents will produce relatively broadband-frequency noise, while high-pressure vents with smaller valves will produce high-frequency noise.

Subsonic (or non-critical flow) low-pressure vent and blowdown applications may not require an inlet diffuser. Contact Dürr Universal for silencer recommendations when a combination of both low-pressure drop and acoustic requirements must be met.

The HV Series is offered in six standard acoustical ratings, ranging from 15 to 70 dB. The HV05 is offered for applications where only minimum noise reduction is required. The HV30 is offered for applications where maximum silencing is required. Acoustic ratings are offered in sizes that cover a wide range of gas flows.

HV20 and HV30 acoustic ratings are offered for standard flow diameters from 2" up to 93". All other acoustic ratings are offered for standard flow diameters of 12" to 93".

APPLICATION ANALYSIS

The following application data is used for vent silencer selection.

Type of gas:

- Molecular weight or specific gravity of the gas
- Ratio of specific heats
- Flow rate (lb/hr, ACFM or SCFM)
- Pressure and temperature upstream of valve
- Maximum allowable pressure drop (psi) for silencer
- Manufacturer's name, valve type and size (if available)
- Un-silenced noise from valve during operating conditions (if available)
- Silenced noise level (at distance from source)
- Silencer inlet size and pressure rating
- Inlet orientation (end inlet, or side inlet)
- Piping arrangement (include schematic if available)
- Other required options

Note: Form 88-0063 is available to record this and other information. Using this information, Dürr Universal will prepare a computer analysis and a comprehensive technical proposal along with a price quotation. Silencer selection is based upon optimization of flow velocity, required acoustical performance, and pressure drop.

Dürr Universal is skilled in the application of process engineering principles that are needed to meet your application requirements. A key element of a successful vent application is establishing pressure drop in the piping, valve, and vent silencer. Valve performance and life can be extended by appropriate distribution of pressure drop in the complete system. In many cases it is possible to reduce the pressure drop across the valve body to less than critical. This can potentially result in reduced valve actuator open/close force requirements. As a result, reduced valve wear caused by cavitation damage and reduced through-valve body noise are added benefits.

Dürr Universal can verify the valve flow and pressure drop characteristics from any valve manufacturer's data sheet. Dürr Universal offers a complete application engineering solution, including determination of blowdown time, bottled volume calculations, and complete valve, pipe treatment, and vent discharge acoustic performance predictions.

1 SILENCER RATINGS BY GRADE CLASSIFICATION

Series	Average Dynamic Insertion Loss [dBA]
HV05	15-20
HV10	20-30
HV15	30-40
HV20	40-50
HV25	50-60
HV30	60-70

Product Description

Vent Silencers

APPLICATION NOTES

Pipe size immediately downstream from a valve affects the noise spectrum octave band distribution. Dürr Universal has developed proprietary methods to predict octave band distribution and accurately select the appropriate balance of reactive and absorptive elements in our vent silencer designs.

Annular vent silencers are assembled with structural members that accommodate thermal expansion in high temperature applications. The acoustic packing is protected by a high temperature erosion barrier and a perforated metal sheet. The sound-absorbent packing is filled under pressure, using compression rings to minimize voids and settling.

The HV Series of vent silencers are designed so the inlet flange and diffuser are matched to the outlet flange rating of the valve. Often, Dürr Universal can create a more cost-effective valve and piping system by using a restrictive diffuser or an orifice plate to stage the system pressure drop. Vent silencers with restrictive diffusers are designed with pressure ratings that match the valve inlet pressure rating. It is important to ensure that the control valve will not malfunction from the rated back pressure of the restrictive diffuser. Please review the valve manufacturers' data sheet.

Customers are encouraged to contact the Compressed Gas Association (CGA) for additional standards relating to preparation and cleaning for applications in pure oxygen service.

CONSTRUCTION FEATURES

Dürr Universal vent silencers are heavy-duty units. The inlet nozzle and diffuser are constructed of steel and fully welded. The diffuser provides controlled pressure expansion to atmosphere and uniform flow distribution through the acoustic section of the silencer.

The lined vent silencer inlet plenum (expansion chamber) is designed with a double shell separated by a layer of acoustic insulation and sound deadening material. The inner shell is solid to prevent shell-radiated noise and the potential of migration of the acoustic packing. The transmission loss across the plenum and bottom head is comparable to the silencer attenuation.

05

Industrial Fan Silencers

General Information _____	36
Sizing Information _____	37
Acousti-Vane _____	38

General Information

Industrial Fan Silencers

Primary air fans, forced draft fans, and induced draft fans generally require some form of acoustical treatment. Most applications require inlet and/or outlet silencers to meet OSHA and other noise requirements. For continuous exposure, a maximum of 90 dBA is generally specified to avoid hearing damage. When conversation near the fan is desired, levels of 80 dBA and less are often needed.

Dürr Universal designs and manufactures a complete line of silencers for application on all fan types. Computer-enhanced technology developed for fan, turbine, and other air-moving equipment enables Dürr Universal to offer a cost-effective solution for every fan silencing application.

Each of the four designs in this section has unique advantages over the others, depending upon the application, pressure drop, and space utilization. This catalog covers standard models and sizes and provides basic information to evaluate the merits of the individual designs for your application. Special configurations, materials, higher temperatures, and sizes are available upon request.

ACOUSTI-VANE

ABSORPTIVE/PARALLEL BAFFLE SILENCER

The Acousti-Vane silencer comes in standard cross-sections and lengths that cover a wide range of applications and provide economical solutions to a broad range of noise conditions. Standard units can be adapted for use in non-standard or application-specific configurations.

The Acousti-Vane is available in three standard models:

LP
The low-pressure drop Acousti-Vane has lower pressure drop than the other two models and is the most economical of the three. The LP is the silencer of choice when pressure drop is critical and a relatively small amount of noise attenuation is needed.

MP
The moderate-pressure, drop Acousti-Vane offers greater acoustic performance than the LP at a slightly higher pressure drop. The MP model meets most noise attenuation specifications.

HP
The high-performance Acousti-Vane provides maximum acoustic performance at a higher pressure drop than the LP or MP. The HP model is ideal for the most demanding acoustical environment.

The steel frame of the Acousti-Vane silencers has high sound transmission loss. The standard two-coat paint system applied is a single coat alkyd primer with a single-coat semigloss light blue alkyd enamel topcoat with a temperature rating of 300°F.

Sizing Information

Industrial Fan Silencers

In order to properly size a fan silencer, the flow area through it must be sufficient to accommodate the maximum flow without imposing excessive pressure drop. The following instructions enable you to select the proper silencer size and determine actual pressure drop. These instructions assume flowing gas is air. For other gases, density, and other corrections, contact Dürr Universal for assistance.

Data required:

- Air flow rate (actual CFM)
- Temperature (°F)
- Pressure (psig)
- Maximum pressure drop (inches of water)

1 Determine maximum velocity to achieve the required pressure drop.

$$V = 4005 \sqrt{\left(\frac{\Delta P}{c}\right) \left(\frac{14.7}{P + 14.7}\right) \left(\frac{T + 460}{530}\right)}$$

V = air or gas velocity, ft/min (see note 1)

ΔP = maximum pressure drop, inches of water

c = silencer pressure drop coefficient (see page 39)

T = air temperature, °F (see note 2)

P = operating pressure, psig (If at atmospheric pressure, pressure ratio is unity and may be omitted from equation. If P exceeds 15 psig, contact Dürr Universal for recommendations.)

2 Determine flow area required.

$$A_{\text{required}} = \frac{Q}{V}$$

A_{required} = flow area required, ft²
Q = air flow rate (actual CFM)

For reference, if SCFM is given rather than ACFM, then convert using the following equation.

$$\text{Actual CFM} = (\text{Standard CFM}) \left(\frac{14.7}{P + 14.7}\right) \left(\frac{T + 460}{530}\right)$$

3 From Table 1 or the tables on page 39 select a size with a flow area equal to or greater than that calculated in step 2.

4 Determine actual gas velocity in feet per minute.

$$V_{\text{actual}} = \frac{Q}{A}$$

A = flow area of size of silencer chosen, ft²

5 Determine actual pressure drop in inches of water.

$$\Delta P_{\text{actual}} = c \left(\frac{V_{\text{actual}}}{4005}\right)^2 \left(\frac{530}{T + 460}\right) \left(\frac{P + 14.7}{14.7}\right)$$

1 CONVERSION— PIPE DIAMETER FROM FLOW AREA

Flow Area (ft ²)	Diameter (in)
0.087	4
0.136	5
0.196	6
0.349	8
0.550	10
0.790	12
1.070	14
1.400	16
1.800	18
2.200	20
2.600	22
3.100	24
3.700	26
4.300	28
4.900	30
5.600	32
6.300	34
7.100	36
7.900	38
8.700	40
9.600	42
10.600	44
11.500	46
12.600	48
15.900	54
19.600	60

Note:

1. Since self noise and aerodynamic noise generation increase with velocity, absorptive silencers are usually sized for 4,000–8,000 ft/min. In no case should the velocity exceed 15,000 ft/min, regardless of pressure drop allowed.
2. Typical attenuation curves indicate the characteristics of the silencer series and are neither a minimum nor a guarantee for an individual silencer. Individual silencer performance can be affected by sound source characteristics including pure tones, flow velocity, adjacent piping, and temperature.

Acousti-Vane

Absorptive Parallel Baffle Type Rectangular Silencers

The Acousti-Vane silencer is designed as a stand-alone silencer or in series with USI's Acousti-Tube silencer. The superior noise attenuation of the Acousti-Vane, combined with the superior high-frequency performance of the Acousti-Tube, provides excellent noise control over a broad spectrum.

ACOUSTI-VANE SILENCERS

The Acousti-Vane silencer comes in standard cross-sections and lengths that cover a wide range of applications and provide economical solutions to a broad range of noise conditions. Standard units can be adapted for use in non-standard or application-specific configurations.

The Acousti-Vane is available in three standard models:

LP

The low-pressure drop Acousti-Vane has the lowest pressure drop and is the most economical of the three.

MP

The moderate-pressure drop unit offers greater acoustic performance than the LP at a slightly higher pressure drop and meets most noise attenuation specifications.

HP

The high-performance Acousti-Vane provides the maximum acoustic performance. The HP model is ideal for the most demanding acoustical environment.

The steel frame for Acousti-Vane silencers has high sound transmission loss. The standard two-coat paint system is a single-coat alkyd primer with a single coat semigloss light blue alkyd enamel topcoat with a temperature rating of 300°F. Optional paint systems are available.

HOW DO I CHOOSE?

Three parameters are needed to select the correct silencer: (1) required acoustic insertion loss, (2) allowable pressure loss, and (3) the flow in actual cubic feet per minute (ACFM) of your equipment.

Follow these steps to find the silencer that is most appropriate for your application.

- 1 Determine the required dynamic insertion loss by octave band** for your equipment and select the minimum silencer length that gives the required loss for each model.
- 2 Determine the allowable pressure drop and flow in ACFM for your application.** To find the pressure drop for gas temperatures other than 60°F, multiply the selected value by $[520/(\text{actual gas temperature } ^\circ\text{F} + 460)]$.
- 3 Choose the Acousti-Vane model for your application.** From the three graphs on page 39, choose the one that has the allowable pressure drop on the Y-axis. Read straight across until the line meets the pressure drop curve. The corresponding X-axis value is the maximum face velocity that will maintain the pressure drop requirement.
- 4 Divide the ACFM by the required face velocity** to find the minimum silencer cross-section that would give the required pressure drop.

Face velocity is defined as the flow rate in ACFM divided by the silencer face area in square feet ($W \times H$).

- 5 Select the silencer** from the tables on page 39. Replace L in the part number with the length of silencer you found in step 2. Specify whether the silencer is an LP, MP, or HP model. The pressure drop will be equal to or slightly below the allowable pressure drop you selected. For special applications that require minimum pressure drop and demanding acoustic specifications, contact Dürr Universal.

Acousti-Vane dimensions. The silencer comes in standard cross-sectional dimensions and standard flange patterns. Flange patterns also can be designed to match your specifications. Silencers may be applied at temperatures that range between -20°F and 200°F. For standard flange patterns, silencer weights, and other details, request Technical Bulletin 94-1327.

EXAMPLE CASE

Acousti-Vane Selection for a Gas Turbine Inlet

- The insertion loss needed to attenuate noise is determined to be 4, 7, 12, 20, 20, 18, 18, 14, 11 in the octave band center frequencies 31.5 Hz–8 kHz.
- Tables 1–3 on page 39 show that a **12-ft LP, 9-ft MP or a 5-ft HP** would satisfy the requirements.
- For this application, the allowable pressure drop is 0.25 inches of water. Which eliminates the HP model (see graph to the right of the table). For purposes of example, the flow in ACFM is assumed to be 30,000.
- The graphs on page 39 show that the maximum face velocity to achieve 0.25 inches of water is 2,000 ft/min for the 12-ft LP and 1,500 ft/min for the 9-ft MP.
- Divide the flow in ACFM by the required face velocity for each silencer:
$$\text{LP} = 30,000/2,000 = 15 \text{ ft}^2$$
$$\text{MP} = 30,000/1,500 = 20 \text{ ft}^2$$
- In Table 4 on page 39, find the silencer size that is equal to or greater than 15 ft² for the LP model and 20 ft² for the MP. In this example, the 4 # 4 LP (at 16 ft² face velocity) and 4 # 6 MP (at 24 ft²) meet your specifications, so you choose between:

AV - 4 x 4 - 12 - LP
or
AV - 4 x 6 - 9 - MP

1 LP (LOW-PRESSURE DROP) MODELS

Silencer Length (ft)	Octave Bands (Hz)								
	31.5	63	125	250	500	1K	2K	4K	8K
3	1	2	4	5	7	5	3	2	1
4	1	3	5	9	9	8	4	4	2
5	2	4	6	10	11	10	7	5	2
6	2	4	7	13	13	12	9	6	4
7	2	5	8	15	15	12	11	7	5
8	3	5	8	16	18	14	13	9	7
9	3	6	9	18	21	16	15	11	9
10	3	6	10	20	24	20	18	14	11
11	4	7	11	22	26	20	18	14	11
12	4	7	12	24	28	20	18	14	11

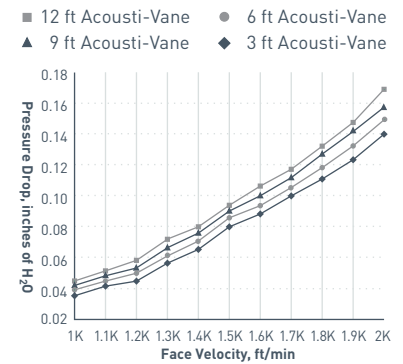

2 MP (MODERATE-PRESSURE DROP) MODELS

Silencer Length (ft)	Octave Bands (Hz)								
	31.5	63	125	250	500	1K	2K	4K	8K
3	3	4	7	10	12	13	11	9	5
4	3	4	8	12	16	16	13	11	7
5	3	5	9	15	20	20	15	12	8
6	3	5	9	18	25	22	18	13	9
7	4	6	10	20	27	24	21	14	9
8	4	6	10	22	29	27	24	15	10
9	5	7	12	24	30	29	26	16	12
10	5	7	14	25	32	32	28	18	14
11	6	8	15	26	34	32	28	18	14
12	6	8	15	28	36	32	28	18	14

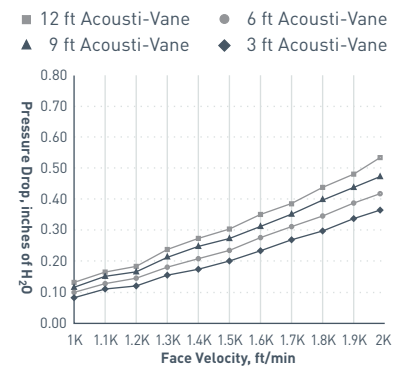

3 HP (HIGH-PERFORMANCE) MODELS

Silencer Length (ft)	Octave Bands (Hz)								
	31.5	63	125	250	500	1K	2K	4K	8K
3	3	5	9	13	15	16	16	12	7
4	3	6	10	16	18	20	20	14	10
5	4	7	12	21	22	23	24	16	12
6	4	8	14	23	26	27	27	19	14
7	5	8	15	25	30	31	31	21	16
8	5	9	16	27	33	36	33	24	18
9	5	9	17	29	36	41	36	27	20
10	6	10	19	31	39	46	39	30	22
11	6	10	19	33	42	47	42	30	23
12	7	11	20	35	45	48	45	30	24

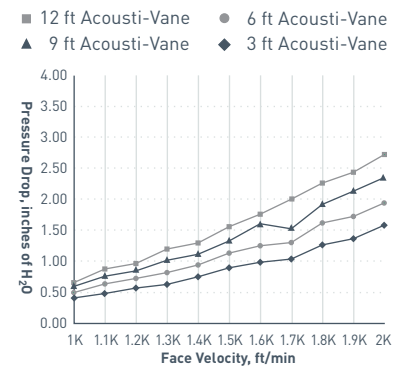

Note: Dynamic insertion loss in dB for face velocities <1500 ft/min, and pressure drop for gas temperatures of 60 °F. To find the pressure drop for gas temperatures other than 60°F, multiply the selected value by $[520/(\text{actual gas temperature } ^\circ\text{F} + 460)]$. Contact Dürr Universal for more information about face velocities >2000 ft/min.

4 ACOUSTI-VANE PART NUMBERS AND FACE AREAS

Part Number (AV-H x W-model)	Face Area (ft ²)
AV-2 x 2-L-m	4
AV-2 x 3-L-m	6
AV-2 x 4-L-m	8
AV-3 x 4-L-m	12
AV-4 x 4-L-m	16
AV-4 x 6-L-m	24
AV-5 x 6-L-m	30
AV-6 x 6-L-m	36
AV-6 x 8-L-m	48
AV-7.5 x 7.5-L-m	56
AV-8 x 8-L-m	64

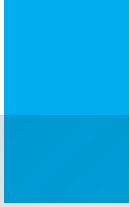

06

Vacuum Pump Liquid Separator-Silencers

General Information _____	42
Application Guide _____	43
RWVS/UWVS Series _____	44
RWSI/UWSI Series _____	45
RVCS/UVCS Series _____	46
RVRS/UVRS Series _____	47

General Information

Vacuum Pump Liquid Separator-Silencers

VACUUM PUMP SYSTEMS

Separator-silencers are used to remove liquid from gas flow vacuum systems using either liquid-sealed rotary positive blowers or liquid ring vacuum pumps (Fig. 1).

Separator-silencers may be required for both the inlet (vacuum) and the discharge (atmospheric) of a vacuum system. Only the most stringent acoustical environments require significant inlet silencing. An inlet separator provides corrosion protection for the vacuum pump by removing most, if not all, of the process liquid before it enters the vacuum pump.

The vacuum pump or blower discharge is normally extremely noisy and requires a high-performance separator-silencer.

OPERATION AND CAPACITY

When a vacuum pump starts operating at normal atmospheric pressure, system pressure drop and power requirements are at their maximum. As the vacuum pump continues to evacuate the system, the inlet pressure decreases so the system pressure losses and power requirements decrease. The inlet volume flow in actual cubic feet per minute (ACFM) stays essentially constant throughout system operation, but because of decreasing inlet pressure, the discharge volume decreases until normal operating conditions are reached.

Vacuum pump capacities at operating conditions are expressed by the inlet volume flow of air and the amount that the inlet pressure has been reduced below atmospheric pressure. Thus, vacuum pump capacities are stated in inlet ACFM at a relative vacuum, usually measured in inches of mercury (Hg).

LIQUID SEPARATION PERFORMANCE

Separator-silencers meet their rated liquid separation efficiency at a nozzle velocity of 5,500 ft/min. At lower velocities their performance improves. At higher velocities their efficiency decreases. The nozzle velocity is the air velocity in the inlet or discharge nozzle and is equal to the actual volume flow rate (ACFM) divided by the nozzle area.

Since the inlet volume flow rate is nearly constant during normal vacuum pump operation, the inlet separator-silencer should be sized so the velocity does not exceed 5,500 ft/min during all phases of operation (Table 1, page 43). The discharge flow rate decreases from startup to normal operation, and in some applications it may be acceptable to exceed a velocity of 5,500 ft/min during startup. If it is not acceptable to discharge liquid during startup, the velocity must be reduced.

If some liquid bypass is allowed during startup, the selection of the discharge separator-silencer should be based on pressure drop. Inlet and discharge separator-silencers require drain systems to remove the liquid. These systems (both inlet and discharge) must provide an adequate drain sealing system or liquid level to offset the vacuum on the inlet side and prevent blowout on the discharge side. See Tables 2 and 3 on the following page for liquid removal data.

TECHNICAL PRESENTATION

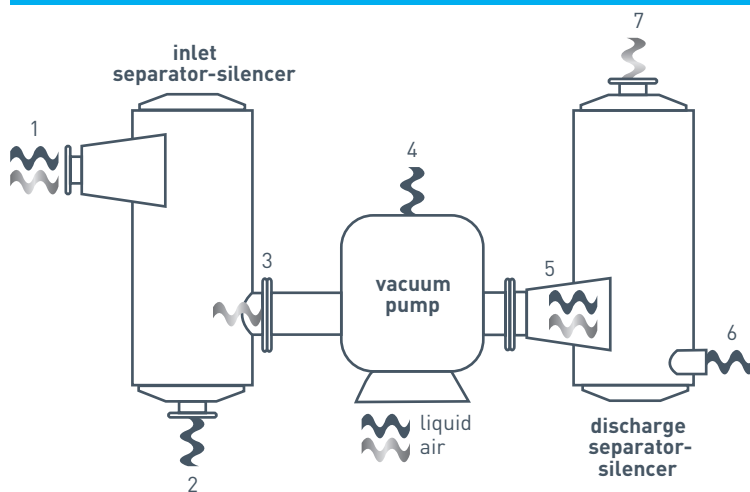

Figure 1

This is an example of a vacuum pump and liquid removal system. Air and liquid enter the inlet separator-silencer during processing (1). Process liquid is removed (2), and air enters the vacuum pump (3). The pump takes in seal liquid (4). Air and seal liquid are pumped into the discharge separator-silencer (5), which removes the liquid (6) and sends the air into the atmosphere (7).

Application Guide

Vacuum Pump Liquid Separator-Silencers

TECHNICAL DETAILS

Separator-silencer pressure drop depends on velocity and pressure. In a vacuum system, pressure drop is at a maximum during startup. Under normal atmospheric conditions, the pressure drop at startup, for either an inlet or discharge separator-silencer, is calculated from the following equation:

$$\Delta P = \frac{c}{477} \left(\frac{ACFM}{p} \right)^2$$

$$= c \left(\frac{V}{4005} \right)^2$$

ACFM = inlet volume flow rate

c = separator-silencer DP coefficient
(see Table 3)

ΔP = pressure drop in inches of water

p = separator-silencer size
(nozzle diameter) in inches

V = velocity in ft/min

If the startup pressure drop is too great, use the flow given for a lower relative vacuum, or calculate a separator-silencer size from this equation:

$$p = 0.214 \sqrt{ACFM} \sqrt{\frac{c}{\Delta P}}$$

c = separator-silencer DP coefficient

ΔP = desired pressure drop in inches of water

p = separator-silencer size
(nozzle diameter) in inches

1 MAXIMUM CAPACITY (INLET ACFM) FOR FULL LIQUID SEPARATION EFFICIENCY AT OPERATING VACUUM

Nominal Size	Operating Vacuum, Inches of Hg						
	0*	5	10	15	18	20	25**
1	30	36	45	60	75	90	98
1½	70	81	101	135	169	204	221
2	120	144	180	241	301	362	393
2½	190	225	282	376	471	565	614
3	270	324	406	541	678	814	884
3½	370	441	552	737	922	1,110	1,200
4	480	576	721	963	1,200	1,450	1,570
5	750	900	1,130	1,500	1,880	2,260	2,450
6	1,080	1,300	1,620	2,170	2,710	3,260	3,530
8	1,920	2,310	2,880	3,850	4,820	5,790	6,280
10	3,000	3,600	4,510	6,020	7,530	9,050	9,800
12	4,300	5,190	6,490	8,660	10,800	13,000	14,100
14	5,900	7,060	8,830	11,800	14,800	17,700	19,200
16	7,700	9,220	11,500	15,400	19,300	23,200	25,100
18	9,700	11,670	14,600	19,500	24,400	29,300	31,800
20	12,000	14,410	18,000	24,100	30,100	36,200	39,300
22	14,500	17,430	21,800	29,100	36,400	43,800	47,500
24	17,300	20,750	26,000	34,700	43,400	52,100	56,500
26	20,300	24,350	30,500	40,700	50,900	61,200	66,400
28	23,500	28,240	35,300	47,200	59,000	70,900	77,000
30	27,000	32,420	40,600	54,100	67,800	81,400	88,400

* This column is used for inlet separator-silencers and discharge separator-silencers with no liquid bypass during startup.

** Capacity at operating vacuum greater than 20" Hg is limited by startup conditions.

2 MAXIMUM LIQUID FLOW IN GPM FOR VARIOUS DRAIN SIZES*

Drain Size (Ø)	Models UWVS, UWSI, RWVS, RWSI	Models UVCS, UVRS RVCS, RVRS
1	15	10
1½	30	20
2	50	35
2½	75	60
3	120	100
3½	150	125
4	200	160
5	300	260
6	450	400
8	800	650
10	1,200	1,000

* Values are based on gravity drain and may be larger with a positive drainage system.

3 PRESSURE DROP COEFFICIENTS AND SEPARATION EFFICIENCY

Model	Pressure Drop Coefficient (C)	Separation Efficiency
RWVS/UWVS	4.0	99%
RWSI/UWSI	3.0	90%
RVCS/UVCS	4.0	99%
RVRS/UVRS	4.5	>99%

RWVS/UWVS Series

Inlet Liquid Separator-Silencers

The RWVS and low-profile UWVS inlet liquid separator-silencers provide corrosion protection for vacuum pumps by removing most of the process liquid before it enters the vacuum pump. These separators are best suited for full vacuum conditions under critical applications which require inlet silencing. The standard primer paint applied to exterior surfaces is a single-coat satin light blue alkyd primer rated for 325°F.

Typical Insertion Loss

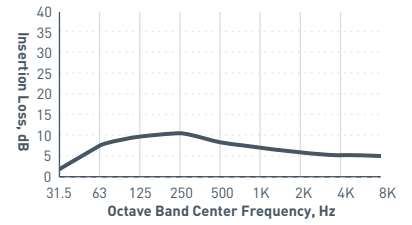

TECHNICAL PRESENTATION

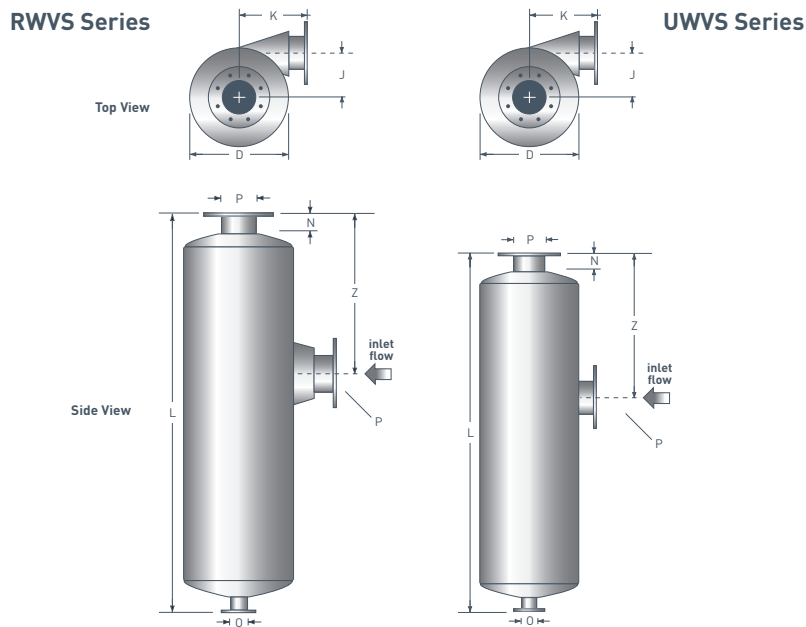

PRODUCT LINE

Model RWVS-	RWVS Part Number 6R-#-AA	Model UWVS-	UWVS Part Number 6U-#-AA	P (nom.)	O (nom.)	N	L	K	K UWVS	Z	J	D	Weight	Rated Capacity*	
														Max. ACFM at Vacuum (Blower Inlet)	Liquid GPM**
4	104	4	104	4	2	3	52	13½	9	19½	5⅞	12¾	76	530	35
5	105	5	105	5	2½	3	58	14½	11	23½	7⅞	16	144	830	55
6	106	6	106	6	3	3	66	18	12	30	8	18	189	1,200	80
8	108	8	108	8	3½	3½	78	21½	14	36	9¾	22	355	2,100	150
10	110	10	110	10	4	3½	85	26	15	37	10½	24	442	3,300	200
12	112	12	112	12	5	3½	97	31½	18	45	13¼	30	630	4,700	300
14	114	14	114	14	6	3½	105	36½	21	47	16	36	1,029	6,000	400
16	116	16	116	16	6	3½	114	41½	24	50	18⅞	42	1,401	7,800	500
18	118	18	118	18	8	3½	135	47	24	68	18⅞	42	1,645	10,000	600
20	120	20	120	20	8	3½	138	52	27	66	21⅞	48	2,925	12,000	800
22	122	22	122	22	10	4½	149	57	30	70	23⅞	54	2,384	15,000	1,000
24	124	24	124	24	10	4½	158	62	33	74	26⅞	60	3,502	18,000	1,200

* Capacities for larger sizes available on request.

** If maximum gas flow is not exceeded for a given separator size, liquid GPM may exceed nominal capacity shown, up to the capacity of the next larger separator.

Note: Dimensions (in) and weights (lbs) are nominal and may vary slightly with production models. Request certified drawings of specific models for exact dimensions.

RWSI/UWSI Series

Inlet Liquid Separator-Silencers

The RWSI and low profile UWSI inlet liquid separator-silencers provide corrosion protection for vacuum pumps by removing most of the process liquid before it enters the vacuum pump. These separators are best suited for full vacuum conditions under critical applications, which require inlet silencing. The RWSI models have a unique profile and larger pipe sizes than the RWVS series. The standard primer paint applied to exterior surfaces is a single-coat satin light blue alkyd primer rated for 325°F. A finish top coat may be applied in the field.

Typical Insertion Loss

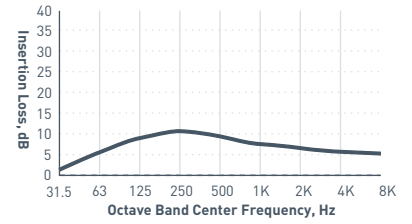

TECHNICAL PRESENTATION

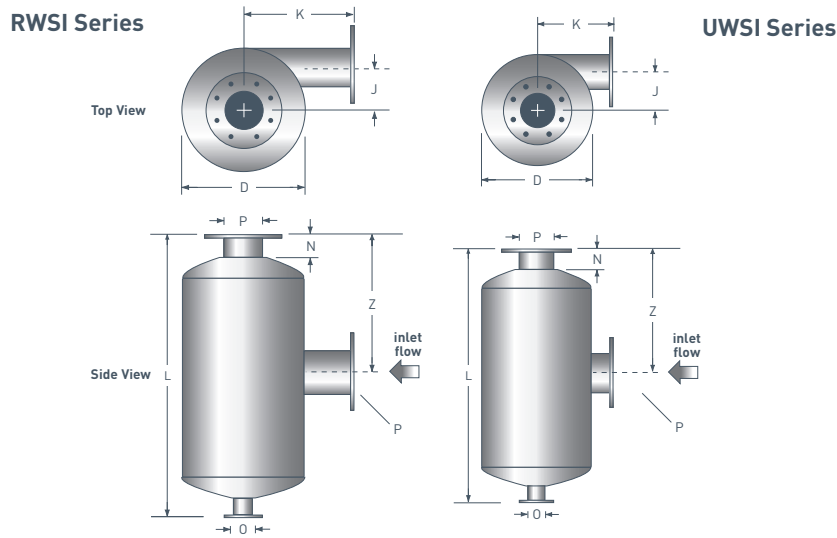

PRODUCT LINE

Model RWSI-	RWSI Part Number 6R-#-AA	Model UWSI-	UWSI Part Number 6U-#-AA	P (nom.)	D	N	L	K	K UWSI	Z	J	O (nom.)	Weight	Rated Capacity*	
														Max. ACFM at Vacuum (Blower Inlet)	Liquid GPM**
4	204	4	204	4	12	3	26	11	9	15	3 ³ / ₄	2	40	530	35
5	205	5	205	5	16	3	31	14 ¹ / ₄	11	18	5 ⁵ / ₁₆	2 ¹ / ₂	82	830	55
6	206	6	206	6	18	3	36	15 ¹ / ₂	12	21	5 ¹¹ / ₁₆	3	108	1,200	80
8	208	8	208	8	22	3 ¹ / ₂	46	18	14	27	6 ¹ / ₁₆	3 ¹ / ₂	202	2,100	150
10	210	10	210	10	24	3 ¹ / ₂	58	23	15	34	6 ⁵ / ₈	4	276	3,300	200
12	212	12	212	12	30	3 ¹ / ₂	68	25 ¹ / ₂	18	40	8 ⁵ / ₈	5	403	4,700	300
14	214	14	214	14	36	3 ¹ / ₂	78	28	21	46	11	6	708	6,000	400
16	216	16	216	16	42	3 ¹ / ₂	88	28	24	52	13	6	950	7,800	500
18	218	18	218	18	42	3 ¹ / ₂	98	30 ¹ / ₂	24	58	12	8	1,050	10,000	600
20	220	20	220	20	48	4 ¹ / ₂	108	33	27	64	14	8	1,308	12,000	800
22	222	22	222	22	54	4 ¹ / ₂	120	35	30	71	16	8	1,619	15,000	1,000
24	224	24	224	24	60	4 ¹ / ₂	130	38	33	77	18	10	2,481	18,000	1,200
26	226	26	226	26	66	4 ¹ / ₂	140	40 ¹ / ₂	36	83	20	10	2,986	21,000	1,400
28	228	28	228	28	72	4 ¹ / ₂	150	43	39	89	22	10	3,554	24,000	1,600
30	230	30	230	30	78	4 ¹ / ₂	160	45 ¹ / ₂	42	95	24	10	4,959	28,000	1,800

* Capacities for larger sizes available on request.

** If maximum gas flow is not exceeded for a given separator size, liquid GPM may exceed nominal capacity shown, up to the capacity of the next larger separator.

Note: Dimensions (in) and weights (lbs) are nominal and may vary slightly with production models. Request certified drawings of specific models for exact dimensions.

RVCS/UVCS Series

Discharge Liquid Separator-Silencers

The RVCS and low profile UVCS models provide high performance liquid separation and noise attenuation. When an inlet separator is not installed, the discharge separator may need to be oversized. The standard primer paint applied to exterior surfaces is a single-coat satin light blue alkyd primer rated for 325°F. A finish top coat may be applied in the field.

Typical Insertion Loss

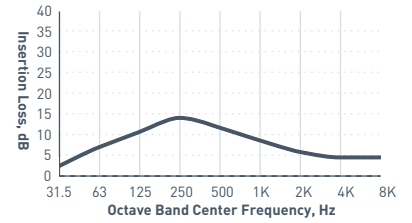

TECHNICAL PRESENTATION

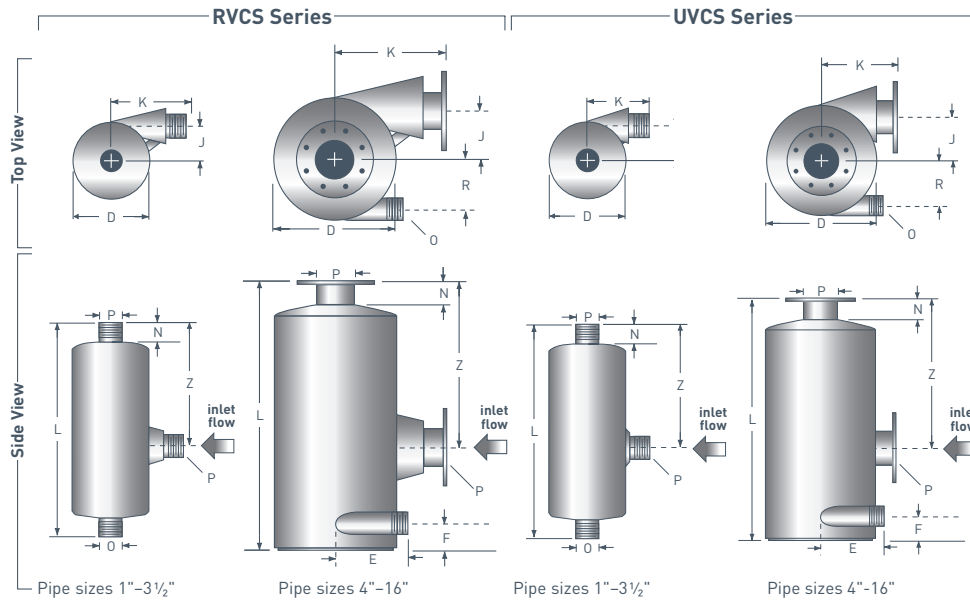

PRODUCT LINE

Model RVCS-	Part Number 6R-#-AA	Model UVCS-	Part Number 6U-#-AA	P (nom.)	D	N	L	K	Low Profile K	E	F	Z	R	J	O (nom.)	Weight
1	301	1	301	1	4½	2	14	6	5¼	—	—	8¾	—	2 ² / ₃₂	1	4
1¼	317	1¼	317	1¼	4½	2	14	6	5¼	—	—	8	—	2 ¹ / ₁₆	1	5
1½	315	1½	315	1½	6	2	17	7	6	—	—	10	—	2¾	1½	10
2	302	2	302	2	8	3	22	9	7	—	—	13	—	3 ¹ / ₁₆	2	15
2½	325	2½	325	2½	10	3	24	10	8	—	—	14	—	4 ⁵ / ₈	2	20
3	303	3	303	3	10	3	27	11	8	—	—	16	—	4 ⁷ / ₁₆	2½	25
3½	335	3½	335	3½	12	3	30	12	9	—	—	18	—	5½	2½	35
4	304	4	304	4	12	3	29	13½	9	8	3	18½	4¼	5 ⁷ / ₁₆	3	50
5	305	5	305	5	16	3	35	14½	11	9	3½	21½	6¼	7 ⁵ / ₁₆	3	95
6	306	6	306	6	18	3	42	18	12	10	3½	27	7¾	8 ³ / ₁₆	3	130
8	308	8	308	8	22	3½	52	21½	14	12	4	32	9¾	9 ¹⁵ / ₁₆	3	240
10	310	10	310	10	24	3½	56	26	15	14	4½	32	10¼	10 ¹¹ / ₁₆	3	300
12	312	12	312	12	30	3½	69	31½	18	16	5	40½	12¾	13 ⁷ / ₁₆	4	445
14	314	14	314	14	36	3½	75	36½	21	16	5	43	15¾	16¼	4	620
16	316	16	316	16	42	3½	88	41½	24	19	6½	52	18¾	18 ⁷ / ₈	4	1,035

All models use a pipe thread connection (MNPT) for the liquid outlet (O).

Sizes 1"–3½" are standard with male pipe thread connection (MNPT).

Sizes 4"–16" are standard with 150# ANSI drilled plate flanges.

Note: Dimensions (in) and weights (lbs) are nominal and may vary slightly with production models. Request certified drawings of specific models for exact dimensions.

RVRS/UVRS Series

Discharge Liquid Separator-Silencers

The RVRS and low profile UVRS models offer better attenuation than the RVCS and UVCS models. For pipe sizes 1"–3", the RVRS has a side liquid outlet, while the RVCS has a vertical liquid outlet. The standard primer paint applied to exterior surfaces is a single-coat satin light blue alkyd primer rated for 325°F. A finish top coat may be applied in the field.

Typical Insertion Loss

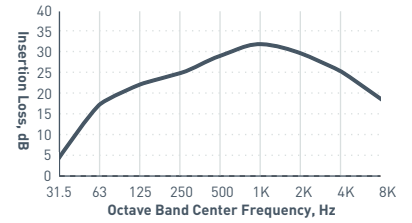

TECHNICAL PRESENTATION

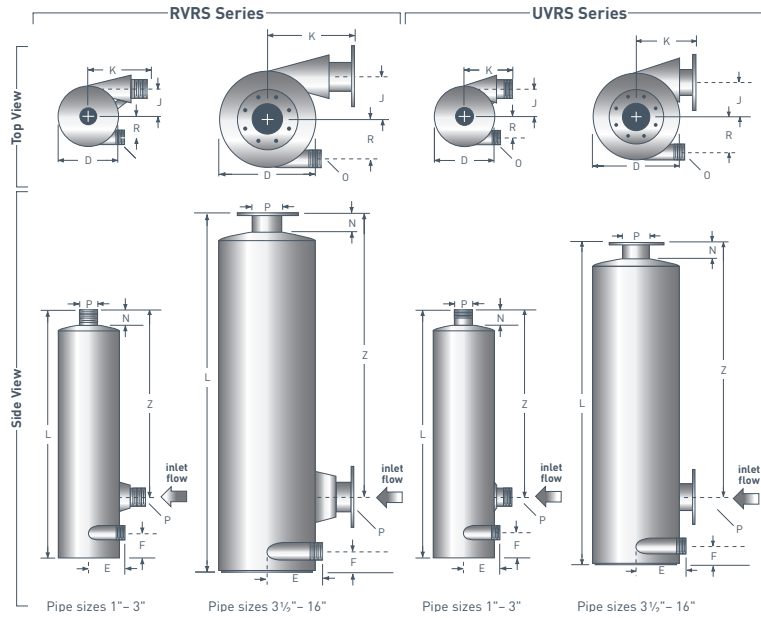

PRODUCT LINE

Model RVRS-	Part Number 6R-#-AA	Model UVRS-	Part Number 6U-#-AA	P (nom.)	D	N	L	K	Low Profile K	E	F	Z	R	J	O (nom.)	Weight
1	401	1	401	1	4½	2	20¾	6	5¼	3½	1¼	15½	1¹⁹⁄₃₂	2¹⁄₁₆	1	10
1¼	417	1¼	417	1¼	4½	2	20¾	6	5¼	3½	1¼	14¾	1¹⁹⁄₃₂	2¹⁄₁₆	1	10
1½	415	1½	415	1½	6	2	25	7	6	4	1¾	19	2³⁄₆₄	2¾	1½	15
2	402	2	402	2	8	2	32⅞	9	7	5	2	25	2¹³⁄₁₆	3¹¹⁄₁₆	2	30
2½	425	2½	425	2½	10	3	35½	10	8	6	3	26	3¹³⁄₁₆	4⁹⁄₈	2	40
3	403	3	403	3	10	3	41	11	8	6	3	31	3⁹⁄₁₆	4⁹⁄₁₆	2½	45
3½	435	3½	435	3½	12	3	44⅞	13	9	7	3	33	4⁹⁄₁₆	5½	2½	55
4	404	4	404	4	12	3	47	13½	9	8	3	36½	4¼	5⁷⁄₁₆	3	70
5	405	5	405	5	16	3	59½	14½	11	9	3½	47	6¼	7⁹⁄₁₆	3	140
6	406	6	406	6	18	3	71¾	18	12	10	3½	57	7¼	8³⁄₁₆	3	244
8	408	8	408	8	22	3½	90¼	21½	14	12	4	71	9¼	9¹⁹⁄₁₆	3	355
10	410	10	410	10	24	3½	103¼	26	15	14	4½	80	10¼	10¹¹⁄₁₆	3	460
12	412	12	412	12	30	3½	128½	31½	18	16	5	101	12¾	13⁷⁄₁₆	4	1,092
14	414	14	414	14	36	3½	141¼	36½	21	16	5	109¼	15¾	16¼	4	1,678
16	416	16	416	16	42	3½	154¼	41½	24	19	6½	118¼	18¾	18⁷⁄₈	4	2,212

All models use a pipe thread connection (MNPT) for the liquid outlet (O).

Sizes 1"–3½" are standard with male pipe thread connection (MNPT). Sizes 4"–16" are standard with 150# ANSI drilled plate flanges.

Note: Dimensions (in) and weights (lbs) are nominal and may vary slightly with production models. Request certified drawings of specific models for exact dimensions.



07

Engine Exhaust Silencers

General Information _____	50
Sizing Information _____	52
EN Series _____	53
ET Series _____	55
ES Series _____	56
QS Series _____	57
QSN Series _____	59
QSE/QSF Series _____	60

General Information

Specialized Engine Exhaust Silencers

TECHNICAL PRESENTATION

EN SERIES SILENCERS

Multi-Chamber Silencers

For the majority of engines and operating conditions, multi-chamber type silencers provide maximum noise attenuation within acceptable back pressure limits. Most naturally aspirated and supercharged engines need this type of silencer. Many turbocharged engines are best silenced with this design also. Factors which influence the choice of silencer design are explained on page 52.

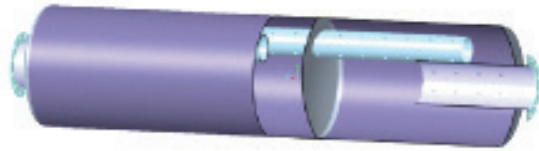

Multi-chamber exhaust silencers for most reciprocating engines.

ET SERIES SILENCERS

Straight-Through Silencers

Some engines require very low exhaust system back pressures for maximum performance. Many turbocharged engines and some naturally aspirated engines fall into this category. For these engines, straight-through, reactive silencers are available to provide adequate silencing while imposing negligible restriction on exhaust gas flow.

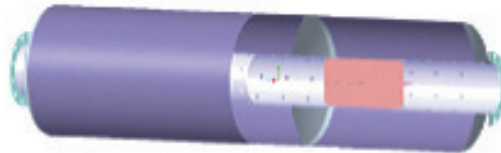

Straight-through exhaust silencers for engines which demand very low back pressures.

ES SERIES SILENCERS

Spark Arresting Silencers

Operating locations exist where fire hazards and safety codes require removal of sparks from exhaust gases. Dürr Universal's spark arrestor silencers are engineered to perform the dual function of spark arresting and silencing for all internal combustion engines.

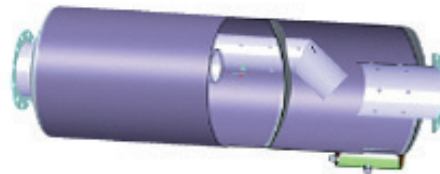

Spark arresting exhaust silencers for engines operating in high potential fire areas.

QS CYLINDRICAL SILENCERS

QuietShield Cylindrical Engine Exhaust Silencers are designed for engine applications that require higher acoustic performance in a cylindrical configuration. These silencers have a high-performance internal design incorporating both reactive and absorptive features that deliver excellent broadband attenuation.



QSN PUCK SILENCERS

QuietShield Puck Engine Exhaust Silencers are designed for engine applications that require good acoustic performance in an economical, low-profile package size to fit inside enclosures. These silencers can be installed inside an enclosure directly above the engine for simplified pipework. Custom inlet configurations to match the engine outlet flanges are also available.

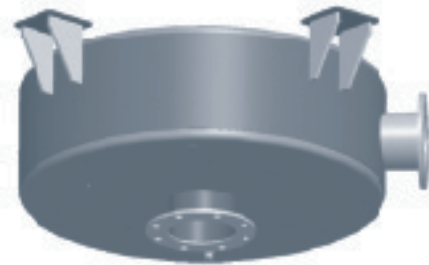

QSE/QSF OVAL SILENCERS

QuietShield Oval Engine Exhaust Silencers are designed for engine applications that require higher acoustic performance in a low-profile package size to fit inside enclosures. These silencers have an internally insulated design that reduces the shell temperature as well as providing excellent attenuation. Custom inlet configurations to match the engine outlet flanges are also available.



Sizing Information

Engine Exhaust Silencers

Dürr Universal's engine exhaust silencers are high-quality, fully welded, reactive silencers designed to reduce exhaust noise on all types of internal combustion engines. Each engine and each operating location requires a unique combination of silencer properties.

For this reason many different silencer models are available to cover most silencing problems. In cases where standard silencers will not meet a particular requirement, custom silencers can be designed to satisfy the application need.

Choosing the correct exhaust silencer for a given engine is an important, although not difficult, task. First of all, a grade of silencing is chosen that will satisfy the noise requirements unique to each engine and location. Secondly, the silencer size is selected to accommodate the specified volume of exhaust flow without imposing excessive back pressure.

SELECTION OF SILENCER TYPE (GRADE)

Each silencer group described on pages 52-61 has a number of a series with different noise attenuation characteristics.

The series letter designation (e.g., EN2) indicates in relative terms the degree of noise attenuation; the higher the number, the greater the attenuation.

- 2 "Industrial" or "Commercial" grade
- 3 "Residential" grade
- 4 "Critical" grade
- 5 "Hospital" grade

The attenuation curves next to the tables on each page indicate the attenuation in dB by octave bands.

These curves are based upon "typical" applications. They will not necessarily define the precise insertion loss for any specific application since the insertion loss achieved may be influenced substantially by many factors, including engine size, type, speed, and unsilenced noise levels and frequency distribution.

SELECTION OF SILENCER SIZE

The open flow area within the silencer should be large enough to accommodate the maximum possible exhaust flow without exceeding the engine manufacturer's maximum allowable back pressure. Improperly sized silencers may cause loss of power or damage to the engine.

Data required:

- Engine exhaust flow (CFM)
- Exhaust temperature (°F)
- Maximum back pressure (inches of water)

The following formulas enable the correct silencer size to be quickly determined.

1 Calculate gas velocity.

$$V = 4005 \sqrt{\frac{\Delta P}{c \left(\frac{530}{T + 460} \right)}}$$

V = gas velocity

ΔP = back pressure, inches of water

c = silencer pressure drop coefficient (Table 1)

T = exhaust gas temperature, °F

2 Calculate required flow area.

$$\text{Flow Area Required (ft}^2\text{)} = \frac{\text{CFM}}{V}$$

3 From Table 2, select the silencer size which has a flow area equal to or greater than that calculated, the actual back pressure can be calculated as follows:

$$V_{\text{actual}} = \frac{\text{CFM}}{\text{silencer flow area}}$$

$$\Delta P = c \left(\frac{V_{\text{actual}}}{4005} \right)^2 \left(\frac{530}{T + 460} \right)$$

1 PRESSURE DROP COEFFICIENTS

Silencer Model	Pressure Drop Coefficient (C)
EN2, 3, 4	4.2
EN5 (1"-10")	4.2
EN5 (12"+)	5.3
ET2	0.5
ET4	1.0
ES2, 3	4.2
QS3, 4, 5	5.0
QSP	5.1
QSF	5.3

2 FLOW AREA/SIZE

Flow Area (ft ²)	Diameter (in)
0.0055	1
0.012	1½
0.022	2
0.034	2½
0.049	3
0.067	3½
0.087	4
0.136	5
0.196	6
0.349	8
0.55	10
0.79	12
1.07	14
1.4	16
1.8	18
2.2	20
2.6	22
3.1	24
3.7	26
4.3	28
4.9	30
5.6	32
6.3	34
7.1	36
7.9	38
8.7	40
9.6	42
10.6	44
11.5	46
12.6	48
15.9	54
19.6	60

EN Series

Multi-Chamber Silencers

EN2, EN3, and EN4 Series Engine Exhaust Silencers are heavy-duty, fully welded units constructed of carbon steel sheet and plate. Each silencer is equipped with flanged connections drilled to match 125/150# ANSI specifications. The standard paint applied to the silencer exterior surfaces is a single-coat aluminum rated for 1000°F.

For EN5 Series, 1" – 3½" are sizes equipped with standard male pipe thread connections. Sizes 4" and larger have flanged connections drilled to match 125/150# ANSI specifications. The addition of "Y" in the model designation indicates a side inlet. Both configurations are fundamentally alike and performance is identical.

TECHNICAL PRESENTATION

EN2, EN3, EN4, EN5 Series

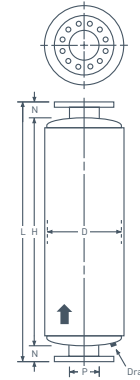

End-In, End-Out Design

EN2Y, EN3Y, EN4Y, EN5Y Series

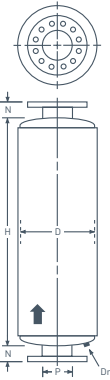

Side-In, End-Out Design

EN2 MULTI-CHAMBER SILENCER

Size	Part Number	D	L	N	H	K	Y		Weight
							Min.	Max.	
4	19-104-AA	12	40	3	34	9	6	15	50
5	19-105-AA	14	46	3	40	10	6½	19	70
6	19-106-AA	16	59	3	53	11	7½	25	120
8	19-108-AA	20	61	3½	54	13½	9	25	190
10	19-110-AA	24	74	3½	67	15½	11	30	280
12	19-112-AA	28	75	3½	68	17½	12½	30	350
14	19-114-AA	36	77	3½	70	21½	14½	30	620
16	19-116-AA	36	113	3½	106	21½	15½	40	900
18	19-118-AA	42	127	3½	120	24½	17½	50	1,150
20	19-120-AA	48	130	4½	121	28½	19	55	1,600
22	19-122-AA	48	142	4½	133	28½	20	60	1,750
24	19-124-AA	54	156	4½	147	31½	22½	70	2,200
26	19-126-AA	60	169	4½	160	34½	24½	80	2,800
28	19-128-AA	60	181	4½	172	34½	25½	80	3,600
30	19-130-AA	60	194	4½	185	37½	27	90	4,500

Note: Dimensions (in) and weights (lbs) are nominal and may vary slightly with production models. Request certified drawings of specific models for exact dimensions.

EN3 MULTI-CHAMBER SILENCER

Size	Part Number	D	L	N	H	K	Y		Weight
							Min.	Max.	
4	20-104-AA	14	47	3	41	10	6	20	70
5	20-105-AA	16	59	3	53	11	7	24	130
6	20-106-AA	18	60	3	54	12	8	24	150
8	20-108-AA	22	73	3½	66	14½	9½	32	280
10	20-110-AA	26	86	3½	79	16½	11	36	390
12	20-112-AA	30	111	3½	104	18½	12½	52	700
14	20-114-AA	36	113	3½	106	21½	14½	52	900
16	20-116-AA	42	127	3½	120	24½	16½	62	1,200
18	20-118-AA	48	129	3½	122	27½	18	62	1,700
20	20-120-AA	48	142	4½	133	28½	19	62	1,900
22	20-122-AA	54	156	4½	147	31½	21½	72	2,300
24	20-124-AA	60	181	4½	172	34½	23½	82	3,300
26	20-126-AA	66	195	4½	186	37½	25	92	4,400
28	20-128-AA	72	209	4½	200	40½	27	103	5,000
30	20-130-AA	72	220	4½	211	40½	28	103	5,400

Note: Dimensions (in) and weights (lbs) are nominal and may vary slightly with production models. Request certified drawings of specific models for exact dimensions.

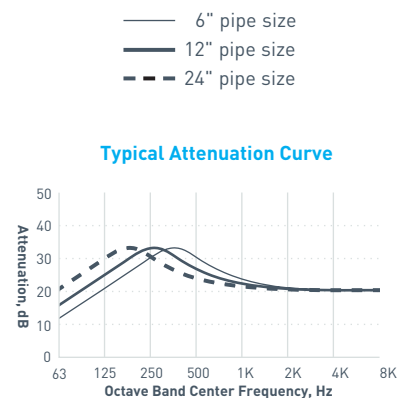
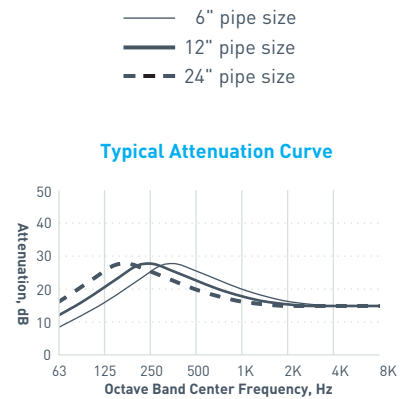

EN Series

Multi-Chamber Silencers

EN4 MULTI-CHAMBER SILENCER

Size	Part Number	D	L	N	H	K	Y		Weight
							Min.	Max.	
4	21-104-AA	14	59	3	53	10	6	26	85
5	21-105-AA	16	71	3	65	11	7	33	120
6	21-106-AA	18	72	3	66	12	8	33	170
8	21-108-AA	24	93	3½	86	15½	9½	42	400
10	21-110-AA	28	111	3½	104	17½	11½	52	550
12	21-112-AA	36	114	3½	107	21½	14	52	950
14	21-114-AA	36	125	3½	118	21½	14½	63	1,100
16	21-116-AA	42	139	3½	132	24½	16½	63	1,350
18	21-118-AA	48	176	3½	169	27½	18	86	2,200
20	21-120-AA	48	190	4½	181	28½	19	96	2,500
22	21-122-AA	54	192	4½	183	31½	21½	96	3,000
24	21-124-AA	60	217	4½	208	34½	23½	107	3,800
26	21-126-AA	66	231	4½	222	37½	25	117	5,200
28	21-128-AA	72	257	4½	248	40½	27	128	6,300
30	21-130-AA	72	280	4½	271	40½	28	139	7,000

Note: Dimensions (in) and weights (lbs) are nominal and may vary slightly with production models. Request certified drawings of specific models for exact dimensions.

EN5 MULTI-CHAMBER SILENCER

Size	Part Number	D	L	N	H	K	Y		Weight
							Min.	Max.	
1	22-101-AA	6	25½	3	19½	6	2½	9	10
1½	22-115-AA	8	27	3	21	7	3½	9	20
2	22-102-AA	10	34	3	28	8	4½	13	30
2½	22-125-AA	12	40	3	34	9	5	16	50
3	22-103-AA	12	46	3	40	9	5	18	60
3½	22-135-AA	14	59	3	53	10	5½	24	90
4	22-104-AA	16	71	3	65	11	6	33	150
5	22-105-AA	18	72	3	66	12	8	33	180
6	22-106-AA	22	85	3	79	14	9	40	300
8	22-108-AA	26	111	3½	104	16½	10	50	480
10	22-110-AA	30	136	3½	129	18½	11½	65	800
12	22-112-AA	36	138	3½	131	21½	14	46	1,050
14	22-114-AA	36	168	3½	161	21½	14½	64	1,400
16	22-116-AA	42	193	3½	186	24½	16½	75	1,750
18	22-118-AA	48	213	3½	206	27½	18	85	2,750
20	22-120-AA	48	227	4½	218	28½	19	85	3,050
22	22-122-AA	54	240	4½	231	31½	21½	96	3,550
24	22-124-AA	60	278	4½	269	34½	23½	106	5,100
26	22-126-AA	66	292	4½	283	37½	25	115	6,800
28	22-128-AA	72	329	4½	320	40½	27	128	8,700
30	22-130-AA	72	352	4½	343	40½	28	139	9,300

Note: Dimensions (in) and weights (lbs) are nominal and may vary slightly with production models. Request certified drawings of specific models for exact dimensions.

— 6" pipe size
 — 12" pipe size
 - - - 24" pipe size

Typical Attenuation Curve

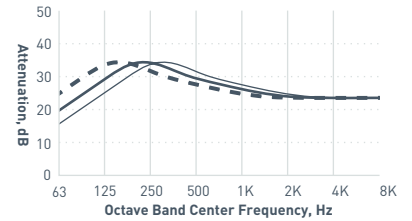

— 6" pipe size
 — 12" pipe size
 - - - 24" pipe size

Typical Attenuation Curve

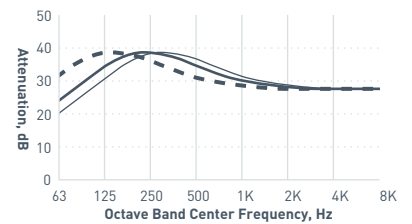

ET Series

Straight-Through Silencers

ET2 and ET4 Series Engine Exhaust Silencers are heavy-duty, fully welded units constructed of carbon steel sheet and plate. Each silencer is equipped with flanged connections drilled to match 125/150# ANSI specifications. The standard paint applied to the silencer exterior surfaces is a single-coat aluminum rated for 1000°F.

Due to low back pressure requirements, no side inlet configuration is cataloged. In some special cases side inlets may be designed for specific applications.

TECHNICAL PRESENTATION

ET2, ET4 Series

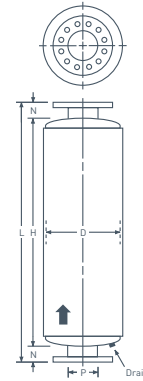

ET2 STRAIGHT-THROUGH SILENCER

Size	Part Number	N	D	L	H	Weight
4	29-104-AA	3	12	40	34	50
5	29-105-AA	3	14	46	40	80
6	29-106-AA	3	16	59	53	150
8	29-108-AA	3½	20	61	54	230
10	29-110-AA	3½	24	74	67	300
12	29-112-AA	3½	28	75	68	420
14	29-114-AA	3½	36	77	70	650
16	29-116-AA	3½	36	113	106	900
18	29-118-AA	3½	42	127	120	1,300
20	29-120-AA	4½	48	130	121	1,500
22	29-122-AA	4½	48	142	133	2,000
24	29-124-AA	4½	54	156	147	2,550
26	29-126-AA	4½	60	169	160	3,400
28	29-128-AA	4½	60	181	172	3,700
30	29-130-AA	4½	66	194	185	5,100

Note: Dimensions (in) and weights (lbs) are nominal and may vary slightly with production models. Request certified drawings of specific models for exact dimensions.

ET4 STRAIGHT-THROUGH SILENCER

Size	Part Number	N	D	L	H	Weight
4	30-104-AA	3	14	59	53	110
5	30-105-AA	3	16	71	65	180
6	30-106-AA	3	18	72	66	220
8	30-108-AA	3½	24	93	86	430
10	30-110-AA	3½	28	111	104	600
12	30-112-AA	3½	36	114	107	1,000
14	30-114-AA	3½	36	125	118	1,100
16	30-116-AA	3½	42	139	132	1,400
18	30-118-AA	3½	48	176	169	2,300
20	30-120-AA	4½	48	190	181	2,700
22	30-122-AA	4½	54	192	183	3,000
24	30-124-AA	4½	60	217	208	4,050
26	30-126-AA	4½	66	231	222	5,800
28	30-128-AA	4½	72	257	248	7,000
30	30-130-AA	4½	72	280	271	7,800

Note: Dimensions (in) and weights (lbs) are nominal and may vary slightly with production models. Request certified drawings of specific models for exact dimensions.

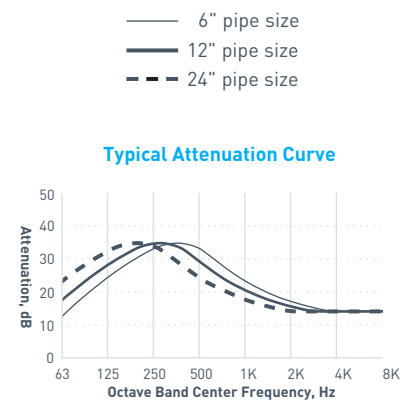
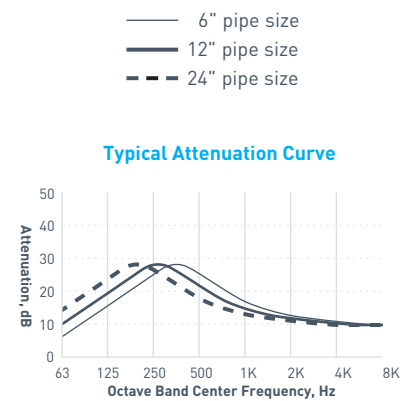

ES Series

Spark Arrestor Silencers

ES2 and ES3 Series spark arresting silencers are heavy-duty, fully welded units constructed of carbon steel sheet and plate. Each silencer is equipped with flanged connections drilled to match 125/150# ANSI specifications. The standard paint applied to the silencer exterior surfaces is a single-coat aluminum rated for 1000°F.

Large capacity spark traps are provided on each unit which can be easily opened for periodic cleaning. Side inlet configurations will be designed on application.

ES2 and ES3 Series may be mounted vertically or horizontally.

TECHNICAL PRESENTATION

ES2, ES3 Series

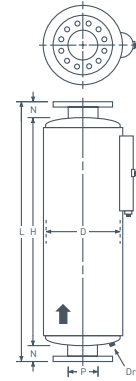

End-In, End-Out Design

ES2 SPARK ARRESTOR SILENCERS

Size	Part Number	N	D	L	H	Weight
4	25-104-AA	3	12	40	34	50
5	25-105-AA	3	14	46	40	70
6	25-106-AA	3	16	59	53	110
8	25-108-AA	3½	20	61	54	200
10	25-110-AA	3½	24	74	67	290
12	25-112-AA	3½	28	75	68	430
14	25-114-AA	3½	36	77	70	650
16	25-116-AA	3½	36	113	106	920
18	25-118-AA	3½	42	127	120	1,350
20	25-120-AA	4½	48	130	121	1,650
22	25-122-AA	4½	48	142	133	1,800
24	25-124-AA	4½	54	156	147	2,400
26	25-126-AA	4½	60	169	160	2,900
28	25-128-AA	4½	60	181	172	3,200
30	25-130-AA	4½	66	194	185	4,600

Note: Dimensions (in) and weights (lbs) are nominal and may vary slightly with production models. Request certified drawings of specific models for exact dimensions.

ES3 SPARK ARRESTOR SILENCERS

Size	Part Number	N	D	L	H	Weight
4	26-104-AA	3	14	47	41	70
5	26-105-AA	3	16	59	53	130
6	26-106-AA	3	18	60	54	160
8	26-108-AA	3½	22	73	66	290
10	26-110-AA	3½	26	86	79	390
12	26-112-AA	3½	30	111	104	650
14	26-114-AA	3½	36	113	106	950
16	26-116-AA	3½	42	127	120	1,200
18	26-118-AA	3½	48	129	122	1,750
20	26-120-AA	4½	48	142	133	1,950
22	26-122-AA	4½	54	156	147	2,450
24	26-124-AA	4½	60	181	172	3,250
26	26-126-AA	4½	66	195	186	4,600
28	26-128-AA	4½	72	209	200	5,400
30	26-130-AA	4½	72	220	211	5,800

Note: Dimensions (in) and weights (lbs) are nominal and may vary slightly with production models. Request certified drawings of specific models for exact dimensions.

— 6" pipe size
— 12" pipe size
- - - 24" pipe size

Typical Attenuation Curve

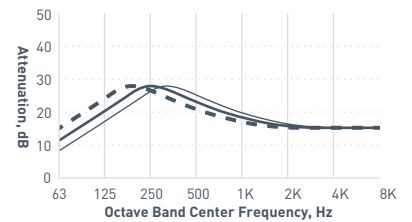

— 6" pipe size
— 12" pipe size
- - - 24" pipe size

Typical Attenuation Curve

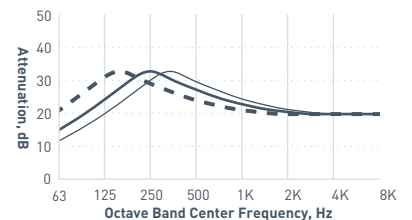

QS Series

Multi-Chamber Silencers

QS2, QS3, QS4, and QS5 Series Engine Exhaust Silencers are heavy-duty, fully welded units constructed of carbon steel sheet and plate. Each silencer is equipped with flanged connections drilled to match 125/150# ANSI specifications. Exterior surfaces receive a coat of heat-resistant paint.

The addition of “Y” in the model designation indicates a side inlet. Both configurations indicates a side inlet. Both configurations are identical.

TECHNICAL PRESENTATION

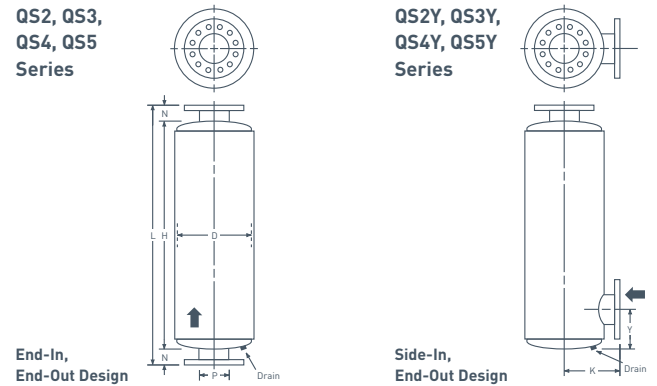

QS2 MULTI-CHAMBER SILENCER

Size	Part Number	D	L	N	H	K	Y	Weight
4	61204F	10	31	3	25	8	6	45
5	61205F	12	38	4	30	10	7	65
6	61206F	14	43	4	35	11	8	95
8	61208F	18	53	4	45	13	10	170
10	61210F	22	63	4	55	15	12	260
12	61212F	26	73	4	65	17	14	375
14	61214F	30	83	4	75	19	15	510
16	61216F	36	98	4	90	22	20	670
18	61218F	42	113	4	105	25	22	845
20	61220F	42	113	4	105	25	24	1,040
22	61222F	48	128	4	120	28	26	1,260

Note: Dimensions (in) and weights (lbs) are nominal and may vary slightly with production models. Request certified drawings of specific models for exact dimensions.

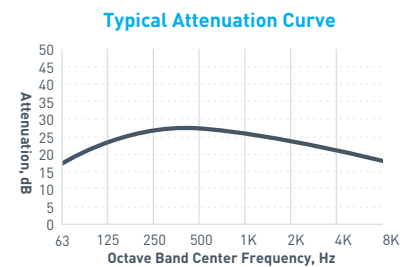

QS3 MULTI-CHAMBER SILENCER

Size	Part Number	D	L	N	H	K	Y	Weight
4	61304F	12	42	3	36	9	6	55
5	61305F	14	50	4	42	11	7	85
6	61306F	16	56	4	48	12	8	125
8	61308F	20	68	4	60	14	10	220
10	61310F	24	80	4	72	16	13	340
12	61312F	30	98	4	90	19	16	490
14	61314F	36	116	4	108	22	18	670
16	61316F	42	134	4	126	25	20	875
18	61318F	42	134	4	126	25	22	1,105
20	61320F	48	152	4	144	28	24	1,360
22	61322F	54	170	4	162	31	26	1,650

Note: Dimensions (in) and weights (lbs) are nominal and may vary slightly with production models. Request certified drawings of specific models for exact dimensions.

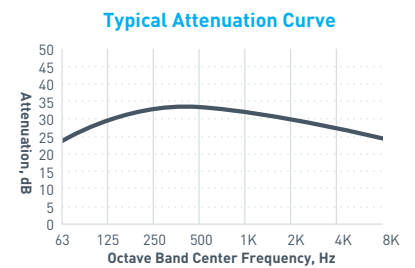

QS Series

Multi-Chamber Silencers

QS4 MULTI-CHAMBER SILENCER

Size	Part Number	D	L	N	H	K	Y	Weight
4	61404F	14	48	3	42	10	6	105
5	61405F	16	56	4	48	12	7	163
6	61406F	20	68	4	60	14	8	235
8	61408F	24	80	4	72	16	10	420
10	61410F	30	98	4	90	19	13	650
12	61412F	36	116	4	108	22	16	940
14	61414F	42	134	4	126	25	18	1,275
16	61416F	42	134	4	126	25	20	1,665
18	61418F	48	152	4	144	28	22	2,110
20	61420F	54	170	4	162	31	24	2,600
22	61422F	60	188	4	180	34	26	3,150

Note: Dimensions (in) and weights (lbs) are nominal and may vary slightly with production models. Request certified drawings of specific models for exact dimensions.

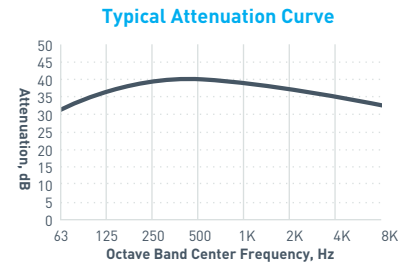

QS5 MULTI-CHAMBER SILENCER

Size	Part Number	D	L	N	H	K	Y	Weight
4	61504F	16	54	3	48	11	6	185
5	61505F	18	62	4	54	13	7	288
6	61506F	22	74	4	66	15	8	415
8	61508F	26	86	4	78	17	10	740
10	61510F	36	116	4	108	22	13	1,150
12	61512F	42	134	4	126	25	16	1,660
14	61514F	42	134	4	126	25	18	2,255
16	61516F	48	152	4	144	28	20	2,945
18	61518F	54	170	4	162	31	22	3,730
20	61520F	60	188	4	180	34	24	4,600
22	61522F	66	206	4	198	37	26	5,570

Note: Dimensions (in) and weights (lbs) are nominal and may vary slightly with production models. Request certified drawings of specific models for exact dimensions.

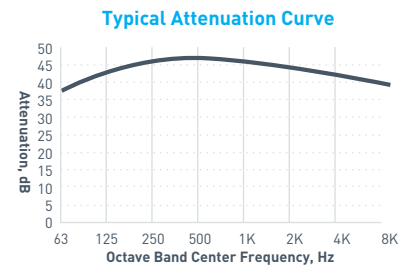

QSN Series

Puck Silencers

QSN3, QSN4, QSN7, and QSN8 Series Puck Exhaust Silencers have a high-performance internal design that delivers excellent silencing in a low-profile package that can be installed inside an enclosure. Each silencer is equipped with flanged connections drilled to match 125/150# ANSI specifications. Exterior surfaces receive a coat of heat-resistant paint.

The addition, the QSN7 and QSN8 Series are Low Shell Temperature (LST) designs with internal shell insulation for lower shell temperature. Add 20% to weight for LST versions. Custom inlet configurations to match the engine outlet flanges are also available.

TECHNICAL PRESENTATION

QSN3, QSN4,
QSN7, QSN8
Series

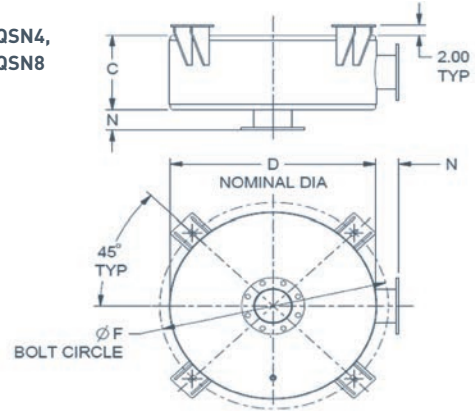

CRITICAL GRADE PUCKS

Size	QSN 3 Non-Insulated Part Number	QSN 7 Insulated Part Number	C	D	N	F	Weight
4	6N-304F	6N-704F	9	26	4	29	110
5	6N-305F	6N-705F	10	28	4	31	120
6	6N-306F	6N-706F	12	36	4	39	250
8	6N-308F	6N-708F	14	42	4	46	330
10	6N-310F	6N-710F	16	48	4	52	420
12	6N-312F	6N-712F	18	54	4	59	540
14	6N-314F	6N-714F	21	66	4	72	970
16	6N-316F	6N-716F	24	72	4	78	1,220
18	6N-318F	6N-718F	27	78	4	84	1,440

Note: Dimensions (in) and weights (lbs) are nominal and may vary slightly with production models. Request certified drawings of specific models for exact dimensions.

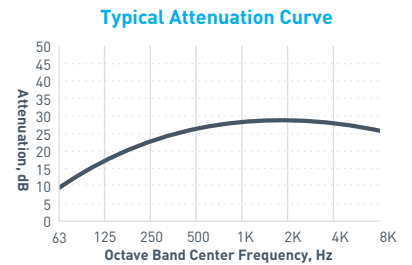

HOSPITAL GRADE PUCKS

Size	QSN 4 Non-Insulated Part Number	QSN 8 Insulated Part Number	C	D	N	F	Weight
4	6N-404F	6N-804F	11	30	4	33	135
5	6N-405F	6N-805F	12	36	4	39	250
6	6N-406F	6N-806F	14	42	4	46	340
8	6N-408F	6N-808F	16	48	4	52	440
10	6N-410F	6N-810F	18	60	4	65	770
12	6N-412F	6N-812F	20	66	4	72	1,020
14	6N-414F	6N-814F	23	72	4	78	1,280
16	6N-416F	6N-816F	26	84	4	90	1,720
18	6N-418F	6N-818F	29	90	4	96	2,330

Note: Dimensions (in) and weights (lbs) are nominal and may vary slightly with production models. Request certified drawings of specific models for exact dimensions.

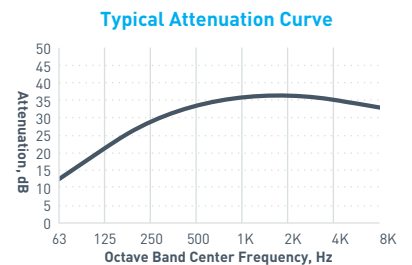

QSE/QSF Series

Oval Silencers

QSE (Single-Inlet) and QSF (Dual-Inlet) Series Oval Exhaust Silencers are designed for engine applications such as generators and compressors that require high-quality, durable products. These silencers have a high-performance internal design that delivers excellent silencing in a low-profile package that can be installed inside an enclosure. Each silencer is equipped with flanged connections drilled to match 125/150# ANSI specifications. Exterior surfaces receive a coat of heat-resistant paint.

All QSE and QSF Series Oval Silencers are Low Shell Temperature (LST) designs with internal shell insulation for lower shell temperature and improved acoustic performance. Custom inlet configurations to match the engine outlet flanges are also available.

TECHNICAL PRESENTATION

QSE Series

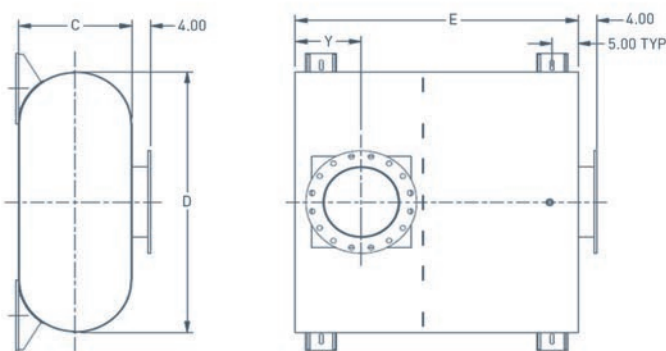

QSF Series

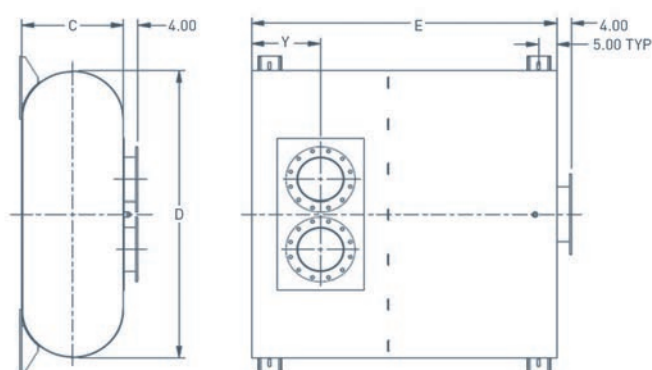

CRITICAL GRADE OVALS

Size	QSE7 Single Inlet Part#	QSF7 Dual Inlet Part#	C	D	E	Y	Weight
4	6E-704F	6F-704F	10	25	25	6	160
5	6E-705F	6F-705F	11	28	28	6	200
6	6E-706F	6F-706F	12	30	30	7	250
8	6E-708F	6F-708F	14	35	35	8	340
10	6E-710F	6F-710F	16	40	40	9	490
12	6E-712F	6F-712F	18	45	45	10	625
14	6E-714F	6F-714F	21	52	52	12	890
16	6E-716F	6F-716F	24	60	60	14	1,130
18	6E-718F	6F-718F	27	68	68	15	1,380
20	6E-720F	6F-720F	30	75	75	17	1,700
22	6E-722F	6F-722F	33	82	82	19	2,050

Note: Dimensions (in) and weights (lbs) are nominal and may vary slightly with production models. Request certified drawings of specific models for exact dimensions.

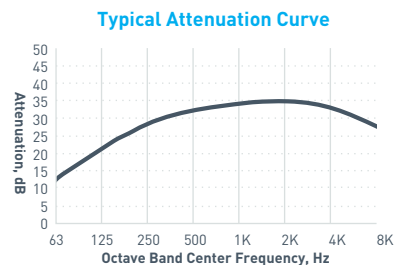

HOSPITAL GRADE OVALS

Size	QSE8 Single Inlet Part#	QSF8 Dual Inlet Part#	C	D	E	Y	Weight
4	6E-804F	6F-804F	11	33	33	7	250
5	6E-805F	6F-805F	12	36	36	8	310
6	6E-806F	6F-806F	14	42	42	9	450
8	6E-808F	6F-808F	16	48	48	11	610
10	6E-810F	6F-810F	19	57	57	13	850
12	6E-812F	6F-812F	22	66	66	15	1,150
14	6E-814F	6F-814F	25	75	75	17	1,520
16	6E-816F	6F-816F	28	84	84	19	1,900
18	6E-818F	6F-818F	30	90	90	20	2,150
20	6E-820F	6F-820F	34	98	98	23	2,980
22	6E-822F	6F-822F	38	108	108	26	3,700

Note: Dimensions (in) and weights (lbs) are nominal and may vary slightly with production models. Request certified drawings of specific models for exact dimensions.

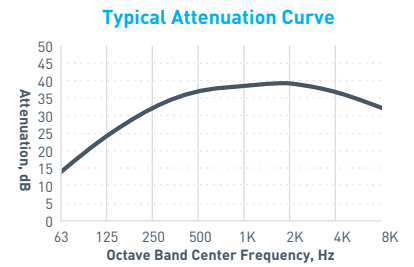

ULTRA-QUIET GRADE OVALS

Size	QSE9 Single Inlet Part#	QSF9 Dual Inlet Part#	C	D	E	Y	Weight
4	6E-904F	6F-904F					
5	6E-905F	6F-905F					
6	6E-906F	6F-906F					
8	6E-908F	6F-908F					
10	6E-910F	6F-910F					
12	6E-912F	6F-912F					
14	6E-914F	6F-914F					
16	6E-916F	6F-916F					
18	6E-918F	6F-918F					
20	6E-920F	6F-920F					
22	6E-922F	6F-922F					

Note: Dimensions (in) and weights (lbs) are nominal and may vary slightly with production models. Request certified drawings of specific models for exact dimensions.

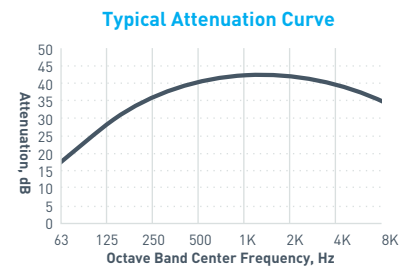



08

Filters and Filter-Silencers

Application Guide _____	64
FH and FSH Series _____	65
FRH and FCRH Series _____	66
FASH Series _____	67
BFH Series _____	68
P-8 and P-12F Series _____	69
Filter Elements _____	70
CCS/CS and CCF/CF Series _____	71
CCS/CS/CCF/CF Filter Elements _____	73
ILF/ILFS Series _____	74
ILFV Series _____	75
ILF/ILFS/ILFV Filter Elements _____	76

Application Guide

Filters and Filter-Silencers

These filters and filter-silencers are available with a variety of filter panels, each with its own restriction characteristics. To reflect that fact, the total pressure drop for a specific filter application is the sum of two pressure drop values:

- 1 The first value is the restriction that can be attributed to the filter housing without filter panels. This value is found in the graph below.
- 2 The second value is the restriction through the filter panel media. These values are taken from the table below.

The pressure drop values for the filter panels are listed in the table as pressure drop in inches of water gauge at various flow rates in CFM. The housing pressure drop is shown in graphical form as a function of air flow in CFM versus pressure drop in inches of water gauge.

To avoid confusion, pressure drop values in the graphs include pipe entrance pressure drops from the atmospheric end of the inlet pipe. These drops are significant, contributing as much as 75% of the total pressure drop, and should not be attributed to the filter. Adding the filter transfers these pressure losses to the interior of the filter housing. A pressure drop measurement at the pressure tap on the filter outlet reflects the total:

- Pipe entrance loss
- Velocity pressure
- Housing restriction

All BFH, RF, and FASH series are still produced. Please contact your Dürr Universal rep for price and availability.

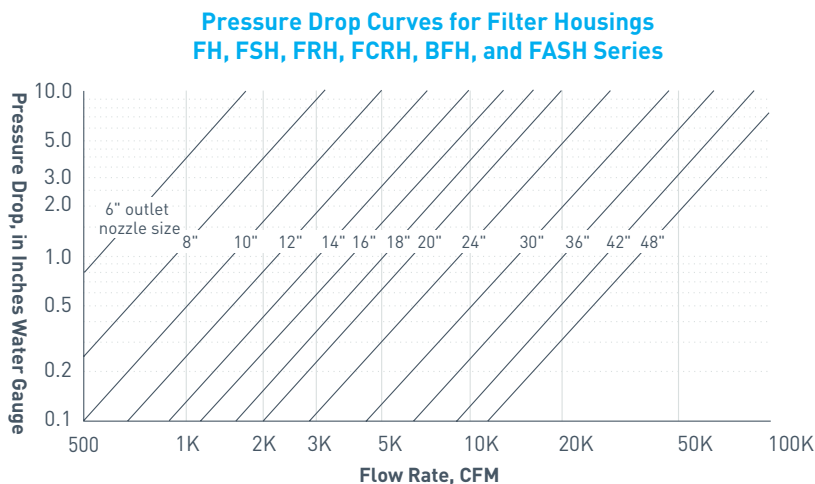

PRESSURE DROP VALUES FOR 20" X 25" PANEL FILTERS, INCHES WATER GAUGE

CFM per filter	W-2	DD-2	P-11	W-2 and DD-2	W-2 and P-11F	P-8 and P-12F	P-5	W-2 and P-5	DD-2 and P-5
500	0.01	0.06	0.09	0.07	0.10	0.80	0.28	0.29	0.34
600	0.02	0.08	0.13	0.10	0.15	0.96	0.35	0.37	0.43
700	0.03	0.11	0.16	0.14	0.19	1.12	0.42	0.45	0.53
800	0.03	0.14	0.21	0.17	0.24	1.28	0.49	0.52	0.63
900	0.04	0.17	0.25	0.21	0.29	1.44	0.56	0.60	0.73
1,000	0.05	0.21	0.30	0.26	0.35	1.60	0.64	0.69	0.85
1,250	0.08	0.31	0.44	0.39	0.52	2.00	0.83	0.91	1.14
1,500	0.12	0.44	0.59	0.56	0.71	2.40	1.04	1.16	1.48

FH/FSH Series

Filters and Filter-Silencers

The FH Series filters and the FSH Series of filter-silencers are ideal when applied to centrifugal blowers, engines, and gas turbines. For use on reciprocating compressors, please contact Dürr Universal for application recommendations.

TECHNICAL PRESENTATION

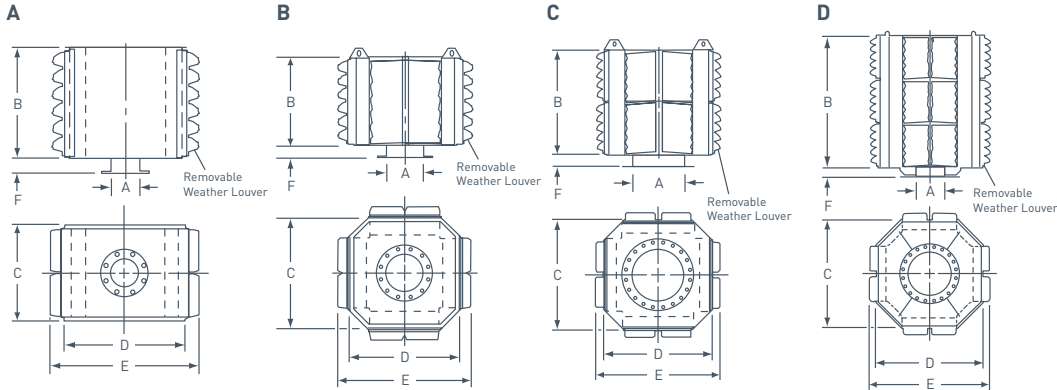

NOISE ATTENUATION

Attenuation, dB	Octave Band Center Frequency, Hz
2	63
3	125
4	250
5	500
8	1,000
13	2,000
14	4,000
13	8,000

The FH and FSH Series use standard panel-style filter elements (20" x 25" x 2") that are available in a variety of media types and efficiencies. The supports for the filter frames inside the housings accommodate conventional 2" deep single panel filters or two (2) filters staged in series for critical service. Typically, in dual-stage systems, a high-efficiency pleated cellulose filter (P-11) is used as a final filter, and a less efficient pleated felt media (DD-2), or wire mesh media (W-2) will be used as primary or prefilter.

The FSH Series of filter-silencers include an integrated internal silencing section for applications that require moderate noise reduction.

All units are fabricated of steel sheet and plate that are welded throughout providing a rugged, long-lasting, trouble-free air filtering system. All models are equipped with pressure taps. Outlets are 125/150# ANSI drilled plate flanges. A standard two-coat paint system, applied to both interior and exterior surfaces, is a single-coat alkyd primer with a single-coat semigloss light blue alkyd enamel topcoat with a temperature rating of 300°F. Suitable mounting legs can be fitted in the field or installed at time of manufacture at extra cost.

All housings come with low-profile UV-stabilized plastic weather louvers. Painted steel weather hoods are available at extra cost.

PART NUMBERS (STANDARD UNITS WITH LOUVERS)

FH Filter		FSH Filter-Silencer		Config.	Cap. CFM	A (nom.)	B	C	D	E	F	Weight w/o filters		Number and Size of Filter Openings
Model	Part Number	Model	Part Number									FH	FSH	
FH-6-2	36-306-AAL	FSH-6-2	37-306-AAL	A	1,000	6	25.50	23.25	23.25	34.25	5.00	115	145	2, 20x25x4
FH-8-2	36-308-AAL	FSH-8-2	37-308-AAL	A	1,750	8	25.50	23.25	23.25	34.25	5.00	125	150	2, 20x25x4
FH-10-2	36-310-AAL	FSH-10-2	37-310-AAL	A	2,750	10	25.50	23.25	23.25	34.25	5.00	130	160	2, 20x25x4
FH-10-4	36-510-AAL	FSH-10-4	37-510-AAL	B	2,750	10	25.50	32.00	32.00	38.09	5.00	170	200	4, 20x25x4
FH-12-4	36-412-AAL	FSH-12-4	37-412-AAL	B	4,000	12	25.50	32.00	32.00	38.09	5.00	175	210	4, 20x25x4
FH-14-4	36-314-AAL	FSH-14-4	37-314-AAL	B	5,400	14	25.50	32.00	32.00	38.09	5.00	180	220	4, 20x25x4
FH-14-8	36-514-AAL	FSH-14-8	37-514-AAL	C	5,400	14	40.75	42.00	42.00	47.32	5.00	340	405	8, 20x25x4
FH-16-8	36-416-AAL	FSH-16-8	37-416-AAL	C	7,000	16	40.75	42.00	42.00	47.32	5.00	350	420	8, 20x25x4
FH-18-8	36-418-AAL	FSH-18-8	37-418-AAL	C	8,900	18	40.75	42.00	42.00	47.32	5.00	350	430	8, 20x25x4
FH-20-8	36-320-AAL	FSH-20-8	37-320-AAL	C	11,000	20	40.75	42.00	42.00	47.32	5.00	365	440	8, 20x25x4
FH-20-12	36-520-AAL	FSH-20-12	37-520-AAL	D	11,000	20	61.00	50.00	50.00	55.31	5.00	600	725	12, 20x25x4
FH-24-12	36-424-AAL	FSH-24-12	37-424-AAL	D	16,000	24	61.00	50.00	50.00	55.31	5.00	610	765	12, 20x25x4
FH-24-16	36-524-AAL	FSH-24-16	37-524-AAL	C	16,000	24	50.75	56.00	56.00	62.13	5.00	695	855	16, 20x25x4
FH-30-16	36-330-AAL	FSH-30-16	37-330-AAL	C	20,500	30	50.75	56.00	56.00	62.13	5.00	795	960	16, 20x25x4
FH-30-24	36-530-AAL	FSH-30-24	37-530-AAL	D	20,500	30	76.00	56.00	56.00	62.13	5.00	1,035	1,340	24, 20x25x4
FH-36-24	36-336-AAL	FSH-36-24	37-336-AAL	D	35,500	36	76.00	56.00	56.00	62.13	5.00	1,085	1,670	24, 20x25x4

Nominal capacity is based on an exit velocity of approximately 5,000 ft/min. Filter element capacity may be greater, but this is unrelated to unit capacity. 4"-deep filter frames will hold single or dual elements. Weights include the weights of weather louvers only. Refer to page 70 for filter element details. **Note:** Dimensions (in) and weights (lbs) are nominal and may vary slightly with production models. Request certified drawings of specific models for exact dimensions.

FRH/FCRH Series

Filters and Filter-Silencers

The FRH Series filters and the FCRH Series of filter-silencers are ideal when applied to centrifugal blowers, engines, and gas turbines. For use on reciprocating compressors, please contact Dürr Universal for application recommendations.

TECHNICAL PRESENTATION

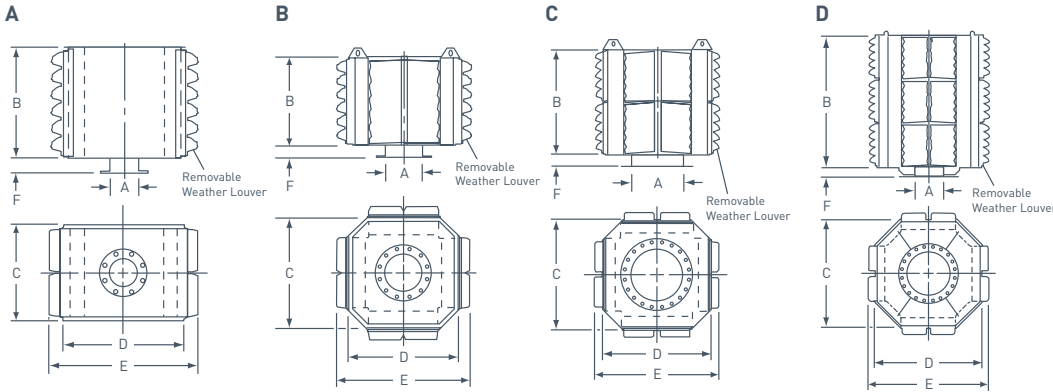

NOISE ATTENUATION

Attenuation, dB	Octave Band Center Frequency, Hz
2	63
3	125
4	250
5	500
8	1,000
13	2,000
14	4,000
13	8,000

The FRH filters and FCRH Series filter-silencers are similar to the FH and FSH Series but have a 2-stage filter system as standard. The second stage consists of a grouping of 12 P-5 cartridge filters for each 20" x 25" x 2" prefilter.

The high-efficiency P-5 cartridge filters have threaded ends that screw into individual receptacles. As each P-5 filter is removed and replaced, less than 4 square inches is exposed to the flow of unfiltered air. As a result, "Hot Swap" changes is an option for these units.

Usually, a moderate efficient panel filter is used as the first stage element. The pleated felt media (DD-2), or the wire mesh media (W-2) can be used in this manner.

The FCRH Series of filter-silencers include an integrated internal silencing section for applications that require moderate noise reduction.

All units are fabricated of steel sheet and plate that are welded throughout providing a rugged, long-lasting, trouble-free air filtering system. All models are equipped with pressure taps. Outlets are 125/150# ANSI drilled plate flanges. A standard two-coat paint system, applied to both interior and exterior surfaces, is a single-coat alkyd primer with a single-coat semigloss light blue alkyd enamel topcoat with a temperature rating of 300°F. Suitable mounting legs can be fitted in the field or installed at time of manufacture at extra cost.

All housings come with low-profile UV-stabilized plastic weather louvers. Painted steel weather hoods are available at extra cost.

PART NUMBERS (STANDARD UNITS WITH LOUVERS)

FRH Filter		FCRH Filter Silencer		Config.	Cap. CFM	A (nom.)	B	C	D	E	F	Weight w/o filters		Number and Size of Filter Openings	Final Filters
Model	Part Number	Model	Part Number									FRH	FCRH		
FRH-8-2	38-308-AAL	FCRH-8-2	39-308-AAL	A	1,750	8	25.50	22.25	40.00	46.50	5.00	205	245	2, 20x25x4	24
FRH-10-2	38-310-AAL	FCRH-10-2	39-310-AAL	A	2,750	10	25.50	22.25	40.00	46.50	5.00	210	255	2, 20x25x4	24
FRH-10-4	38-510-AAL	FCRH-10-4	39-510-AAL	B	2,750	10	25.50	42.00	42.00	48.38	5.00	375	385	4, 20x25x4	48
FRH-12-4	38-412-AAL	FCRH-12-4	39-412-AAL	B	4,000	12	25.50	42.00	42.00	48.38	5.00	380	435	4, 20x25x4	48
FRH-14-4	38-314-AAL	FCRH-14-4	39-314-AAL	B	5,400	14	25.50	42.00	42.00	48.38	5.00	395	440	4, 20x25x4	48
FRH-14-8	38-514-AAL	FCRH-14-8	39-514-AAL	C	5,400	14	40.75	47.00	47.00	48.38	5.00	655	735	8, 20x25x4	96
FRH-16-8	38-416-AAL	FCRH-16-8	39-416-AAL	C	7,000	16	40.75	47.00	47.00	52.33	5.00	665	745	8, 20x25x4	96
FRH-18-8	38-418-AAL	FCRH-18-8	39-418-AAL	C	8,900	18	40.75	47.00	47.00	52.33	5.00	665	755	8, 20x25x4	96
FRH-20-8	38-320-AAL	FCRH-20-8	39-320-AAL	C	11,000	20	40.75	47.00	47.00	52.33	5.00	675	765	8, 20x25x4	96
FRH-20-12	38-520-AAL	FCRH-20-12	39-520-AAL	D	11,000	20	61.00	60.00	60.00	65.88	5.00	1,265	1,515	12, 20x25x4	144
FRH-24-12	38-424-AAL	FCRH-24-12	39-424-AAL	D	16,000	24	61.00	60.00	60.00	65.88	5.00	1,315	1,565	12, 20x25x4	144
FRH-24-16	38-524-AAL	FCRH-24-16	39-524-AAL	C	16,000	24	50.75	62.00	62.00	72.50	5.00	1,440	1,640	16, 20x25x4	192
FRH-30-16	38-330-AAL	FCRH-30-16	39-330-AAL	C	20,500	30	50.75	62.00	62.00	72.50	5.00	1,490	1,690	16, 20x25x4	192
FRH-30-24	38-530-AAL	FCRH-30-24	39-530-AAL	D	20,500	30	76.00	72.00	72.00	78.50	5.00	2,130	2,480	24, 20x25x4	288
FRH-36-24	38-336-AAL	FCRH-36-24	39-336-AAL	D	35,500	36	76.00	72.00	72.00	78.50	5.00	2,230	2,630	24, 20x25x4	288

Nominal capacity is based on an exit velocity of approximately 5,000 ft/min. Filter element capacity may be greater, but this is unrelated to unit capacity.

2"-deep filter frames will hold single or dual elements. Refer to page 70 for filter element details.

Note: Dimensions (in) and weights (lbs) are nominal and may vary slightly with production models. Request certified drawings of specific models for exact dimensions.

FASH Series

Absolute Filter

For centrifugal compressors, blowers, and gas turbines.

TECHNICAL PRESENTATION

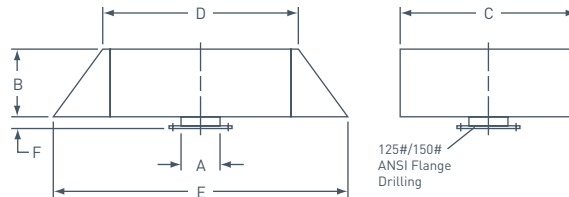

NOISE ATTENUATION

Attenuation, dB	Octave Band Center Frequency, Hz
2	63
3	125
4	250
5	500
8	1,000
13	2,000
14	4,000
13	8,000

The Dürr Universal FASH Series absolute filter silencer represents the ultimate high-efficiency air filtration for industrial applications. The FASH Series uses both primary prefilter and a secondary stage final, panel filter elements, with a combined depth of 20". The combination provides exceptional efficiency on ultra-fine particulates. The combination of the primary and secondary filter elements have a large surface area for low flow resistance and high particulate retention capacity. Filtration efficiency exceeds 99.97% on particles 0.3 microns.

The FASH Series utilizes a unique fluid seal for the final (secondary) panel filter element. A channel, provided on the P-12F final filter holds a stable silicone gel providing a 100% bypass-free system when applied to the most severe of conditions.

When installed, the filters are staged, so that the less costly roughing pad, and the primary filter can be serviced more frequently than the final secondary stage filter. Under typical conditions, the pre-filter will be serviced about once a year, while the final filter may provide two or three years of service.

Specification details for the P-8 prefilter and the P-12F final filter can be found on the P-8 and P-12F Specification Sheet.

The FASH Series includes an integral silencing section providing a moderate degree of noise attenuation. The FASH Series filters are constructed using heavy-duty carbon steel and plate. The units are welded throughout for a rugged, long-lasting, trouble-free filter system.

All FASH Series filters include weatherhoods, pressure tap, and outlet flanges with 125/150# ANSI drilled plate flanges. A standard two-coat paint system, applied to both interior and exterior surfaces, is a single-coat alkyd primer with a single-coat semigloss light blue alkyd enamel topcoat with a temperature rating of 300°F. Suitable mounting legs can be fitted in the field or provided at time of manufacture. Mounting legs will be quoted based on application preferences.

PART NUMBERS

Model	Part Number	Nom. Cap. CFM	A	B	C	D	E	F	Weight	Number of Elements
FASH-10-4	40-510-AA	2,750	10	25½	32	32	55	3½	225	2
FASH-12-4	40-412-AA	4,000	12	25½	32	32	55	3½	240	2
FASH-14-4	40-314-AA	5,400	14	25½	32	32	55	3½	245	4
FASH-14-8	40-514-AA	5,400	14	40¾	42	42	61	4½	465	4
FASH-16-8	40-416-AA	7,000	16	40¾	42	42	61	4½	475	4
FASH-18-8	40-418-AA	8,900	18	40¾	42	42	61	4½	485	8
FASH-20-8	40-320-AA	11,000	20	40¾	42	42	61	4½	495	8
FASH-20-12	40-520-AA	11,000	20	61	50	50	69	4½	810	8
FASH-24-12	40-424-AA	16,000	24	61	50	50	69	4½	850	8
FASH-24-16	40-524-AA	16,000	24	50¾	52	52	75	4½	850	12
FASH-30-16	40-330-AA	20,500	30	50¾	52	52	75	4½	955	12
FASH-30-24	40-530-AA	20,500	30	76	62	62	85	4½	1,535	16
FASH-36-24	40-336-AA	35,500	36	76	62	62	85	4½	1,865	16

Nominal capacity is based on exit velocity of approximately 5,000 ft/min. Filter element capacity may be greater, but this is unrelated to unit capacity. 4" deep filter frames will hold single elements or dual elements. Weights do not include the weight of the filter elements. Weight is measured with steel weatherhoods. Louvered weatherhoods reduce weight by 7 lb per filter opening. Refer to page 70 for filter element details.

Note: Dimensions (in) and weights (lbs) are nominal and may vary slightly with production models. Request certified drawings of specific models for exact dimensions.

BFH Series

Filter

The Dürr Universal BFH line of intake filters are designed for application to compressors, blowers, engines, and gas turbines. For reciprocating compressor applications, contact Dürr Universal for recommendations.

TECHNICAL PRESENTATION

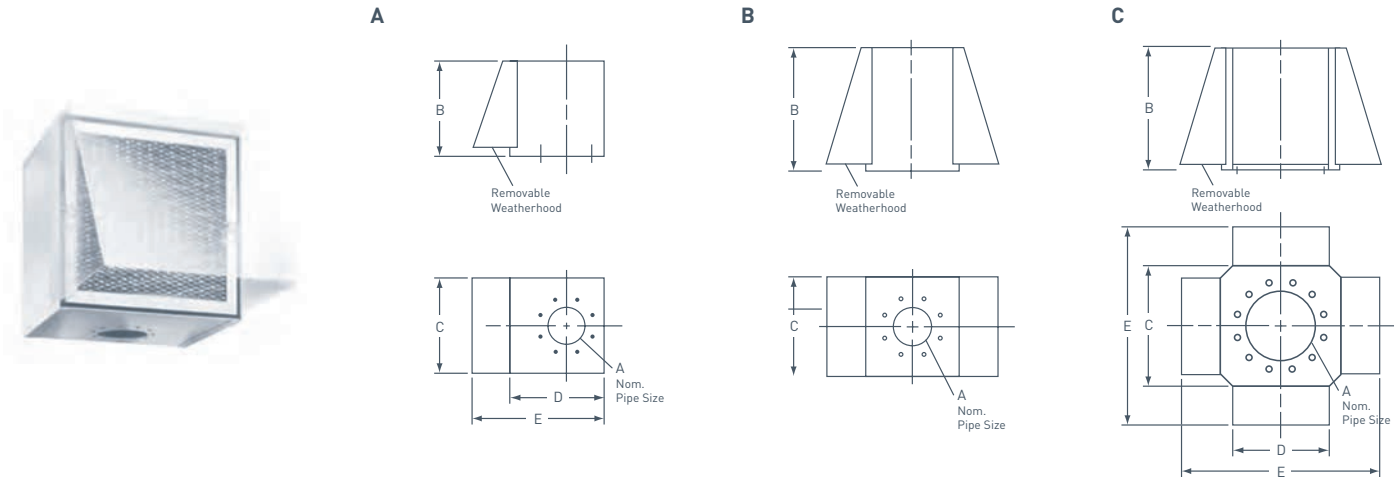

The Dürr Universal BFH Series air filter is a compact, inexpensive unit designed to accommodate the standard 20" x 25" x 2.0" metal sided panels, single stage only, that are available in various media types and efficiencies. If noise is a concern, the BFH filter can be used in series with a separate inlet silencer.

The BFH Series units are fabricated of steel sheet and plate and are fullywelded to provide a rugged long-lasting, trouble-free air filtering system.

The filter comes with removable low-profile UV stabilized plastic weather louvers. Optional metal weather hoods are available. The filter bottom plate includes an opening and bolting pattern matching 125/150# ANSI Flange specifications. A standard two-coat paint system, applied to both interior and exterior surfaces, is a single-coat alkyd primer with a single-coat semigloss light blue alkyd enamel topcoat with a temperature rating of 300°F.

PART NUMBERS (STANDARD UNITS WITH LOUVERS)

Filter	Part Number	Config.	Capacity CFM	A	B	C	D	E	Weight w/o Filters	Number and Size of Filter Openings
BFH-4-1	35-304-AAL	A	450	4	20.50	26.25	15	18	45	1, 20 x 25 x 2
BFH-5-1	35-305-AAL	A	700	5	20.50	26.25	16	19	50	1, 20 x 25 x 2
BFH-6-1	35-306-AAL	A	1,000	6	20.50	26.25	17	20	55	1, 20 x 25 x 2
BFH-8-2	35-308-AAL	B	1,750	8	25.50	21.25	20	26.50	65	2, 20 x 25 x 2
BFH-10-2	35-310-AAL	B	2,750	10	25.50	21.25	23	29.50	70	2, 20 x 25 x 2
BFH-10-4	35-410-AAL	C	2,750	10	25.50	27.25	27.25	33.50	85	4, 20 x 25 x 2
BFH-12-4	35-412-AAL	C	4,000	12	25.50	27.25	27.25	33.50	85	4, 20 x 25 x 2
BFH-14-4	35-314-AAL	C	5,000	14	25.50	27.25	27.25	33.50	85	4, 20 x 25 x 2

Nominal capacity is based on an exit velocity of 5,000 ft/min. Filter element capacity may be greater, but this is unrelated to the filter housing capacity. Weights shown do not include the weight of the filter elements. 2" deep panel air filters (20" x 25" x 2") are used on the BFH Series. Pleated cellulose media, felt media, or crimped galvanized steel wire mesh are available. Refer to page 70 for filter element details.

Note: Dimensions (in) and weights (lbs) are nominal and may vary slightly with production models. Request certified drawings of specific models for exact dimensions.

P-8/P-12F Series

Prefilter and Final Filter

For centrifugal compressors, blowers, engines, and gas turbines.
For reciprocating compressors, contact Dürr Universal for recommendations.

TECHNICAL PRESENTATION

P-8 and P-12F absolute filter elements are not cleanable; they must be replaced with new elements according to these instructions.

FOR NEW UNITS—MEASURING PRESSURE DROP

When new filters or filter-silencers are installed, make the following two pressure drop measurements and record the results for future reference:

- 1 Measure the pressure drop with all filters installed.
- 2 Measure the pressure drop with the P-8 prefilters removed, but the P-12F final filters installed; this gives the pressure drop across the final filters.
- 3 Subtract the second value from the first to find the pressure drop across the prefilters.

POLYESTER PAD REPLACEMENT

Replace the polyester pad when visibly dirty.

FILTER REPLACEMENT

After the units have been in service and the filters are loaded, determine whether the filters need to be replaced as follows:

- 1 Measure the pressure drop with all filters installed and subtract the value measured at installation, when the filters were clean, to find the pressure drop across both loaded filters.
- 2 Measure the pressure drop with the P-8 prefilters removed, but with the P-12F final filters installed; subtract the value measured at installation, when the final filters were clean; if the difference is more than 2", replace the final filters.
- 3 Subtract the second value from the first to find the pressure drop across the prefilters. If the difference is more than 2", replace the final filters.

P-8 Prefilter

P-12F Final Filter

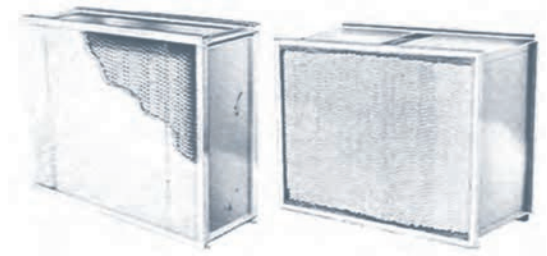

	P-8	P-12F
Seal	Sponge Neoprene Gasket	Silicon Fluid Seal
Filter Media	Waterproof Glass	Waterproof Glass
Separators	Aluminum	Aluminum
Frame	16-Gauge Galvanized Steel	16-Gauge Galvanized Steel
Construction	Pleated Media over Corrugated Separators	Pleated Media over Corrugated Separators
Tools Needed for Removal	Part Number 80-0457 Removal Tool (Need 2)	Part Number 80-0457 Removal Tool (Need 2)

Model	Part Number	Weight	Size	Pressure Drop, Clean Filter	Pressure Drop, Clean Filter
P-8 Prefilter	81-0398 81-0400*	27	19½ x 24½ x 8	Individually tested and certified 85% efficient by N.B.S. test	0.6" water at 1,250 CFM
P-12F Final Filter	81-0429	47	19½ x 24½ x 11½	Individually tested and certified 99.97% efficient by D.O.P. test for particle size 0.3 micron	0.6" water at 1,250 CFM

*The polyester pad (part number 81-0400) is a 2" thick "roughing" filter that fits on the face of the P-8 prefilter. It may be purchased separately in cartons of 12 and should be replaced when it is visibly dirty. Follow the service instructions for replacement.

Note: Dimensions (in) and weights (lbs) are nominal and may vary slightly with production models.
Request certified drawings of specific models for exact dimensions.

Filter Elements

Filter and Filter-Silencers

Dürr Universal offers a wide range of sizes and types of air filters and filter-silencers for application on air-moving equipment and internal combustion engines. This catalog covers our standard off-the-shelf models. Most models are stocked for immediate shipment. Special types and configurations, as well as larger sizes that are not cataloged, are quoted upon application to meet specific requirements.

TECHNICAL PRESENTATION

EASY TO SPECIFY AND ORDER

When you work with Dürr Universal, you can simply provide the flow conditions and equipment manufacturer's information, and we can recommend a filter or filter-silencer best suited for your application. Using your information, we can prepare a comprehensive technical proposal and price quotation.

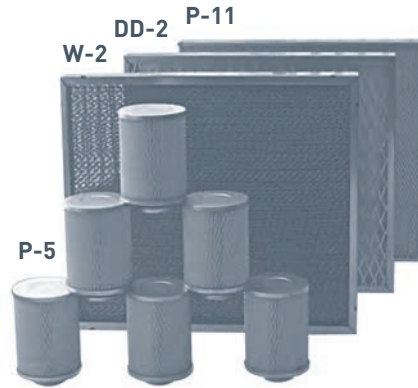

	W-2	DD-2	P-11	P-5
Frame Material	Galvanized Steel	Galvanized Steel	Galvanized Steel or Stainless Steel	Injection Molding Polystyrene
Media	Crimped Galvanized Steel Wire Mesh	Felted Synthetic (Polyester)	Pleated Cellulose	Pleated Cellulose
Dry or Treated	Oil-Free Adhesive (81-0323)	Dry	Dry	Dry
Cleaning	Soap or Solvent Wash	Compressed Air or Soap Wash	Compressed Air	Compressed Air

Resistance Filter Type	Available Sizes	Part Number	Weight (lbs)	Rated Flow (CFM)	Efficiency	Initial Resistance at Rated Flow (inches of H ₂ O)
W-2-40	20 x 25 x 2	81-0165	12.5	1,250	93% on 10 microns	0.08
DD-2-40	20 x 25 x 2	81-0173	10	1,250	99% on 10 microns	0.31
P-11	20 x 25 x 2	81-0326	8	1,250	99.5% overall 99% at 10 microns 75% at 2 microns	0.44
P-5	5" diameter x 6.68" long	81-0328*	0.6	105	99.5% overall 99% at 10 microns 75% at 2 microns	0.83

*48 per case

For dry filters, cleaning instructions are included with each unit. Filter types DD-2 and W-2 are available with stainless steel or aluminum frames.

W-2 Filters are available with stainless steel or aluminum media.

Note: Dimensions (in) and weights (lbs) are nominal and may vary slightly with production models.

Request certified drawings of specific models for exact dimensions.

CCS/CS/CCF/CF Series

Filter-Silencers and Filters

The Dürr Universal Series of cartridge filters and filter-silencers offer high-performance filtration and silencing in a convenient economical cartridge configuration. Choose from four standard models for pipe sizes from 1/2" to 16" with flow capacities ranging from 15 to 7,700 CFM.

Three types of filter elements are available: pleated cellulose media, pleated felt media, or wire mesh media.

The CCF and CF series filters are high-quality air filters without a silencing section. The CF Series uses a top plate to provide ease of servicing and to axially seal the filter element in place. The CCF Series uses a weather hood to protect the filter element.

The CCS and CS series filters are high-quality air filters including a built-in silencing section. The CS Series uses a top plate to provide ease of servicing and to axially seal the filter element in place. The CCS Series uses a weather hood to protect the filter element.

TECHNICAL PRESENTATION

PERFORMANCE BENEFITS

Durability

Weather hoods for CCF and CCS sizes 2-1/2" through 5" are rugged blue ABS composite material that is paintable. Optional painted metal weather hoods are available at extra cost. All other components are carbon steel construction painted with a single-coat semigloss light blue alkyd enamel rated for 300°F.

High Performance

Unique design options combined with the latest manufacturing techniques ensure optimum performance and long life even under the most demanding of conditions.

Functional

Choice of filter only or filter-silencer.

Easy to Maintain

Removable lightweight weather hoods (available on CCF and CCS models), or removable top plate (available on CF and CS models) for easy access and servicing of the filter element.

Versatile

Interchangeable filter elements provide options for filtration performance in the same housing.

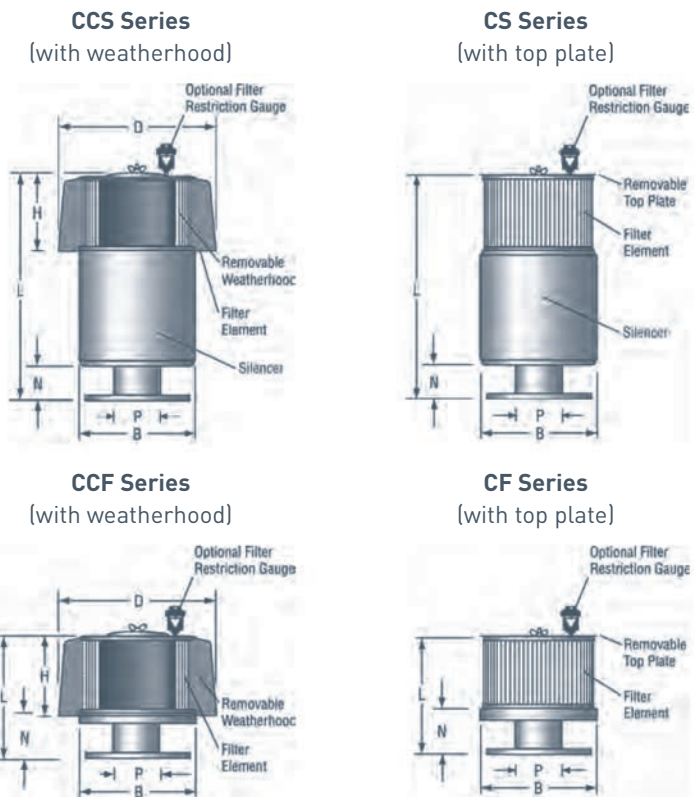

CCS/CS/CCF/CF Series

Filter-Silencers and Filters

PART NUMBERS				
Pipe Size	CCS	CS	CCF	CF
1/2	34-K50-TT*	34-M50-TT*		
3/4	34-K70-TT*	34-M70-TT*	Sizes 1/2" - 1" Use CCS or CS Series	
1	34-K01-TT*	34-M01-TT*		
1 1/4	34-K21-TT*	34-M21-TT*	34-L21-TT*	34-N21-TT*
1 1/2	34-K15-TT*	34-M15-TT*	34-L15-TT*	34-N15-TT*
2	34-K02-TT*	34-M02-TT*	34-L02-TT*	34-N02-TT*
2 1/2	34-K25-TT*	34-M25-TT*	34-L25-TT*	34-N25-TT*
3	34-K03-TT*	34-M03-TT*	34-L03-TT*	34-N03-TT*
3 1/2	34-K35-TT*	34-M35-TT*	34-L35-TT*	34-N35-TT*
4	34-K04-TT*	34-M04-TT*	34-L04-TT*	34-N04-TT*
4	34-K04-AA*	34-M04-AA*	34-L04-AA*	34-N04-AA*
5	34-K05-TT*	34-M05-TT*	34-L05-TT*	34-N05-TT*
5	34-K05-AA*	34-M05-AA*	34-L05-AA*	34-N05-AA*
6	34-K06-AA*	34-M06-AA*	34-L06-AA*	34-N06-AA*
8	34-K08-AA*	34-M08-AA*	34-L08-AA*	34-N08-AA*
10	34-K10-AA*	34-M10-AA*	34-L10-AA*	34-N10-AA*
12	34-K12-AA*	34-M12-AA*	34-L12-AA*	34-N12-AA*
14	34-K14-AA*	34-M14-AA*	34-L14-AA*	34-N14-AA*
16	34-K16-AA*	34-M16-AA*	34-L16-AA*	34-N16-AA*

NOISE ATTENUATION, CCS/CS	
Attenuation, dB	Octave Band Center Frequency, Hz
5	63
8	125
10	250
12	500
14	1,000
14	2,000
14	4,000
14	8,000

PRESSURE DROP, ALL MODELS	
Pressure Drop (in. of H ₂ O)	Percentage of Rated Flow
0.7	50%
1.6	75%
2.8	100%
4.4	125%
6.3	150%

*Specify "P" at end of part number for unit with pleated paper elements, "F" for pleated felt or "W" for wire mesh. Refer to page 73 for filter element details.

P (size)	Rated Flow Cap. (CFM)	D	H	B	N				L				Approx. Weight with Paper Elements			
					CCF	CCS	CF	CS	CCF	CCS	CF	CS	CCF	CCS	CF	CS
1/2	15	8.00	3.13	6.00	Use CCS Series	—	Use CS Series	—	Use CCS Series	6.50	Use CS Series	6.50	Use CCS Series	7	Use CS Series	7
3/4	22	8.00	3.13	6.00	—	—	—	—	6.50	6.50	6.50	6.50	7	7	7	7
1	35	8.00	3.13	6.00	—	—	—	—	6.50	6.50	6.50	6.50	7	7	7	7
1 1/4	60	9.00	3.50	6.50	—	—	—	—	3.50	7.88	3.50	7.88	9	10	5	9
1 1/2	75	9.00	3.50	6.50	—	—	—	—	3.50	7.88	3.50	7.88	9	10	5	9
2	120	9.00	3.50	6.50	—	—	—	—	3.50	7.88	3.50	7.88	8	10	5	8
2 1/2	190	13.44	6.75	10.00	1.00	1.00	1.00	1.00	7.50	17.69	7.13	17.31	11	19	10	18
3	275	13.44	6.75	10.00	1.00	1.00	1.00	1.00	7.50	17.69	7.13	17.31	10	18	9	17
3 1/2	375	13.44	6.75	10.00	1.13	1.13	1.13	1.13	7.63	17.69	7.25	17.31	13	20	12	19
4 [NPT]	500	13.44	6.75	10.00	1.13	1.13	1.13	1.13	7.63	17.69	7.25	17.31	12	19	11	18
4 (flanged)	500	13.44	6.75	10.00	4.00	3.00	4.00	3.00	10.50	19.63	10.13	19.25	14	21	13	20
5 [NPT]	750	13.44	6.75	10.00	1.81	1.81	1.81	1.81	8.38	18.25	8.00	17.88	12	19	11	18
5 (flanged)	750	13.44	6.75	10.00	4.00	3.00	4.00	3.00	10.50	19.56	10.13	19.13	16	23	15	22
6	1,100	18.00	9.50	14.00	4.00	3.00	4.00	3.00	13.31	25.25	12.75	24.75	31	43	23	35
8	2,200	20.00	18.00	14.00	4.00	3.00	4.00	3.00	21.88	33.88	21.38	33.38	43	56	30	43
10	3,000	24.00	11.50	18.00	4.00	3.00	4.00	3.00	15.38	29.25	14.19	28.13	52	83	41	67
12	4,300	24.00	11.50	18.00	4.00	3.00	4.00	3.00	15.38	29.25	14.19	28.13	64	91	48	75
14	5,900	30.00	15.44	24.00	4.00	3.00	4.00	3.00	19.38	36.25	18.25	35.06	97	143	75	121
16	7,700	30.00	15.44	24.00	4.00	3.00	4.00	3.00	19.38	36.25	18.25	35.06	101	145	79	123

All models have a 1/8" FNPT tap for installation of a gauge or manometer to monitor pressure drop. Sizes 1/2" through 3 1/2" are standard with female pipe thread connection (FNPT). Sizes 4" and 5" are available with female threads or flanges. Please specify "threaded" or "flanged" when you order 4" and 5" sizes. Sizes 6" through 16" are standard with 150# ANSI drilled plate flanges. Rated capacity is based upon exit velocity of approximately 5,500 ft/min. If pressure drop allowance permits, capacity may be increased by as much as 50%.

Note: Dimensions (in) and weights (lbs) are nominal and may vary slightly with production models. Request certified drawings of specific models for exact dimensions.

CCS/CS/CCF/CF Filter Elements

Three types of filter elements are available for Dürr Universal's cartridge filters and filter-silencers. Pleated paper elements provide the highest efficiency and are considered standard. Pleated felt and wire mesh elements are available for less demanding service with respect to efficiency. The three types of elements are completely interchangeable and will fit all CCS, CS, CF or CCF filter housings.

TECHNICAL PRESENTATION



PLEATED PAPER ELEMENT

Specifications

- High-quality industrial grade filter paper—pleated and oven-cured during production.
- Oven-cured plastisol end caps with molded sealing beads.
- Media efficiency: 99% on 2 microns.
- Maximum operating temperature: 185°F for units with ½" through 16" pipe sizes.

Service Instructions

Because of the low cost of the paper element, it is generally treated as a consumable and replaced when dirty. However, depending on customer preference, the paper element may be cleaned with compressed air and reused.

Compressed Air Cleaning

Carefully direct compressed air (100 PSI maximum) through the dry element, opposite the normal direction of flow. After cleaning, inspect carefully for holes or cracks. If damaged, replace element. See IOM 94-1341



PLEATED FELT ELEMENT

Specifications

- Durable polyester felt media—pleated.
- Oven-cured plastisol end caps with molded sealing beads (larger elements for pipe sizes 10", 12", 14", and 16" have metal end caps with closed cell rubber gaskets).
- Media efficiency: 98% on 10 microns.
- Maximum operating temperature: 185°F for units with ½" through 8" pipe sizes, 185°F for units with 10" through 18" pipe sizes using elements with metal end caps.

Service Instructions

Pleated felt elements may be cleaned with compressed air (as described for paper elements) or water and reused.

Water Cleaning

Rap gently to dislodge accumulated dirt, soak thoroughly approximately 15 minutes in warm water and mild detergent. Rinse thoroughly under low-pressure water. Air dry—do not dry with compressed air. After cleaning, inspect carefully for holes or cracks. If damaged, replace element. See IOM 94-1341



WIRE MESH ELEMENT

Specifications

- Galvanized wire-mesh media—corrugated construction.
- May be cleaned and reused indefinitely.
- Wire mesh elements are considered "roughing" filters and are not recommended for applications which require efficient filtration of fine particles.
- Approximate efficiency: 93% on 10 microns. When correctly treated efficiency will vary with element oil or adhesive coverage.
- Maximum operating temperature: 200°F for ½" through 16" with oil-free adhesive (flash point of adhesive is 235°F) and 300°F for ½" through 16" without adhesive.

Service Instructions

New elements are delivered pre-treated with Dürr Universal's oil-free adhesive. See page 76 for details. For best efficiency, wire mesh elements must be retreated after each cleaning. Spray the element on both sides with Dürr Universal Oil-Free Adhesive, P/N 81-0323, following the directions on the container. For oil treatment, dip the element in SAE 30-50 motoroil and drain thoroughly before using.

Cleaning

To clean wire mesh elements, wash in solvent or warm water and detergent in a container large enough for complete immersion of element. Rinse completely, drain, and either air dry or use compressed air. After cleaning and drying, retreat the element with oil-free adhesive or oil as described. See IOM 94-1341

P (Nom.)	Replacement Element Part Number		
	Paper	Felt	Wire Mesh
½	81-0470	81-1202	81-1035
¾	81-0470	81-1202	81-1035
1	81-0470	81-1202	81-1035
1¼	81-0471	81-1203	81-1036
1½	81-0471	81-1203	81-1036
2	81-0471	81-1203	81-1036
2½	81-1063, 81-0472 (old)	81-1205, 81-1204 (old)	81-1038, 81-1037 (old)
3	81-1063, 81-0472 (old)	81-1205, 81-1204 (old)	81-1038, 81-1037 (old)
3½	81-1063	81-1205	81-1038
4	81-1063	81-1205	81-1038
5	81-1063, 81-0474 (old)	81-1205, 81-1206 (old)	81-1038, 81-1039 (old)
6	81-0475	81-1207	81-1040
8	81-0475 (2)	81-1207 (2)	81-1040, (2) 81-1199 (old)
10	81-1163	81-1209	81-1200
12	81-1163	81-1209	81-1200
14	81-1164	81-1210	81-1201
16	81-1164	81-1210	81-1201

ILF/ILFS Series

In-line Filters

Dürr Universal's ILF and ILFS Series of in-line air filters are designed to withstand the demanding requirements of pressure and vacuum applications. The ILF and ILFS filters come in standard sizes ranging from 3" to 18", with flow capacities from 275 to 9,700 CFM. Three types of filter elements are offered: pleated cellulose, pleated felt, or wire mesh media.

TECHNICAL PRESENTATION

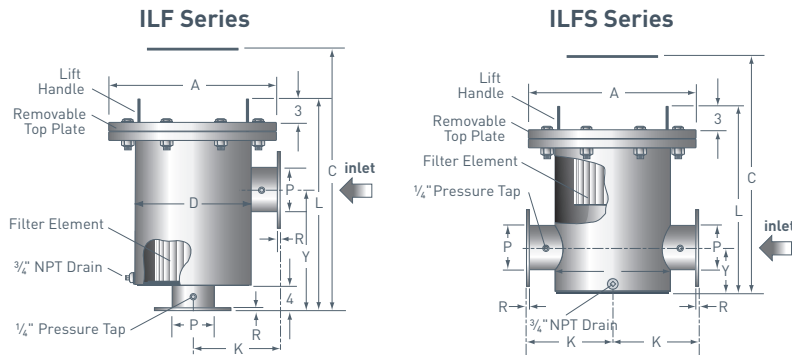

DURABLE CONSTRUCTION

- Carbon steel construction painted with a single-coat semigloss light blue alkyd enamel rated for 300°F.
- Easily removable top cover plate for access and servicing of the filter element.
- ASME Code construction and special materials (stainless steel) are available.

CUSTOMIZE TO YOUR APPLICATION

- Optional design features for special production and assembly conditions are available.
- Choose an ILF model for an "L" configuration, or an ILFS for opposed connections.
- Interchangeable cellulose, felt, or wire media elements for desired filtration efficiency and service life.
- Built-in taps to accommodate pressure gauges.

PRODUCT LINE

Model	Part Number	P (nom.)	D	L	R	Y	C	A	K	Weight (est.)	Rated Cap. (CFM)	Number of Bolts
ILF-3	34-A03-TT*	3	14	24.25	—	15½	27	20	11	100	275	8
ILF-4	34-A04-AA*	4	14	24.25	⅜	15½	27	20	11	110	500	8
ILF-5	34-A05-AA*	5	14	25.25	⅜	16	28	20	11	120	750	8
ILF-6	34-A06-AA*	6	16	28.00	½	18¼	34	22	12	120	1,100	8
ILF-8	34-A08-AA*	8	18	39.50	½	28¼	45	24	13	140	1,920	8
ILF-10	34-A10-AA*	10	22	35.50	½	22	42	28	15	295	3,000	12
ILF-12	34-A12-AA*	12	22	37.50	½	23	44	28	15	315	4,300	12
ILF-14	34-A14-AA*	14	28	41.00	½	27	52	34	18	450	5,900	12
ILF-16	34-A16-AA*	16	30	43.75	½	28	55	36	19	500	7,700	12
ILF-18	34-A18-AA*	18	30	43.75	½	29	57	36	19	505	9,700	12
ILFS-3	34-B03-TT*	3	14	23.00	—	5	29	20	11	115	275	8
ILFS-4	34-B04-AA*	4	14	23.00	⅜	5	29	20	11	125	500	8
ILFS-5	34-B05-AA*	5	14	23.00	⅜	5½	29	20	11	130	750	8
ILFS-6	34-B06-AA*	6	16	27.00	½	6	36	22	12	170	1,100	8
ILFS-8	34-B08-AA*	8	20	35.00	½	7	44	26	14	245	1,920	8
ILFS-10	34-B10-AA*	10	24	34.00	½	8½	44	30	16	365	3,000	12
ILFS-12	34-B12-AA*	12	24	37.00	½	10	47	30	16	395	4,300	12
ILFS-14	34-B14-AA*	14	30	44.00	½	11	58	36	19	605	5,900	12
ILFS-16	34-B16-AA*	16	36	48.00	½	12½	62	42	24	895	7,700	12
ILFS-18	34-B18-AA*	18	36	52.00	½	13	66	42	24	945	9,700	12

The C dimension is clearance required to remove elements. Non-ASME code construction is suitable for 15" PSI maximum working pressure or 20" Hg operating vacuum. Estimated weight does not include elements. Size 3" is standard with male pipe thread connection (MNPT). Sizes 4" through 18" are standard with 125/150# ANSI drilled plate flanges. Rated capacity is based upon flow velocity of approximately 5,500 ft/min. If pressure drop allowance permits, capacity may be increased by as much as 50%.

Refer to page 76 for filter element details.

*Specify "P" at end of part number for unit with pleated paper elements, "F" for pleated felt or "W" for wire mesh.

ILFV Series

Vacuum Service In-line Air Filters

Dürr Universal's ILFV Series of in-line air filters are designed to provide an economical alternative to the ILF Series. Ten Standard connection sizes are available ranging from 2" to 14" with flow ratings from 120 to 5,900 CFM. There are three choices of filter elements available: pleated cellulose, pleated felt, or wire mesh. See the diagram below for additional information.

TECHNICAL PRESENTATION

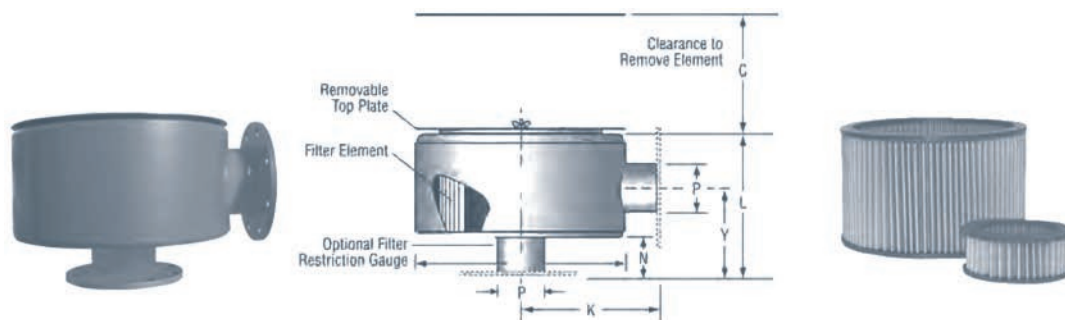

OPTIONAL FILTER RESTRICTION GAUGE

Dürr Universal 81-1234 filter restriction gauge provides a convenient, accurate means of monitoring filter restriction as the filter element is increasingly loaded with contaminant. In-line filters are standard with threaded connections for direct mounting of the restriction gauge.

FILTER ELEMENTS

Pleated cellulose media elements offer the highest filtering efficiency and are considered standard. Pleated felt media filter elements are offered for less demanding applications. Both element types are completely interchangeable, and will fit any size ILFV filter. See element and accessories pages 74 and 76 for replacement element part numbers.

PRODUCT LINE

Model	Part Number	P (nom.)	D	L	N	Y	C	K	Weight (est. lbs.)	Rated Cap. (CFM)
ILFV-2	34-D02-TT*	2	14	11.13	3.50	6.44	7	10	31	120
ILFV-2½	34-D25-TT*	2½	14	11.13	3.50	6.44	7	10	28	190
ILFV-3	34-D03-TT*	3	14	11.13	3.50	6.44	7	10	32	275
ILFV-4	34-D04-TT*	4	14	11.13	3.50	6.44	7	10	34	500
ILFV-5	34-D05-AA*	5	18	14.32	3.50	7.75	10	12	60	750
ILFV-6	34-D06-AA*	6	18	22.56	3.50	12	8.50	12	79	1,100
ILFV-8	34-D08-AA*	8	24	14.75	3.50	9.13	11	15	110	2,200
ILFV-10	34-D10-AA*	10	24	24.25	3.50	13	11	15	137	3,000
ILFV-12	34-D12-AA*	12	30	18.75	3.50	11.13	14.50	18	186	4,300
ILFV-14	34-D14-AA*	14	30	32.69	3.50	17	15	18	259	5,900

All models have a 1/8" FNPT for installation of a gauge or manometer to monitor pressure drop.

The "C" dimension is clearance required to remove filter elements.

Non-ASME Code construction is suitable for 15" Hg. vacuum.

Not applicable for pressure applications.

Rated capacity is based on flow velocity of approximately 5,500 ft/min.

If pressure drop allowance permits, capacity may be increased by as much as 50%.

Sizes 5" through 14" flange are standard with plate flanges, drilled per ANSI Standard for each size.

Sizes 2" through 4" are standard with Male Pipe Threaded Inlet and outlet (MNPT).

Weight does not include filter elements. See Filter Element section for details.

*Specify "P" at the end of the Part Number for Paper Element, "F" for synthetic felt media, or "W" for wire mesh media.

Note: Dimensions (in) and weights (lbs) are nominal and may vary slightly with production models.

Request certified drawings of specific models for exact dimensions.

ILF/ILFS/ILFV Filter Elements

ILF/ILFS SERIES

P Size (nom.)	Pleated Cellulose	Felt	Wire Mesh
3	81-1063	81-1205	81-1038
4	81-1063	81-1205	81-1038
5	81-1063	81-1205	81-1038
6	81-0475	81-1207	81-1040
8	81-0475 (2 req'd)	81-1207 (2 req'd)	81-1040 (2 req'd)
10	81-1163	81-1209	81-1200
12	81-1163	81-1209	81-1200
14	81-1164	81-1210	81-1201
16	81-1164	81-1210	81-1201
18	81-1164	81-1210	81-1201

ILFV SERIES

P Size (nom.)	Pleated Cellulose	Felt	Wire Mesh
2	81-1063	81-1205	—
2½	81-1063	81-1205	—
3	81-1063	81-1205	—
4	81-1063	81-1205	—
5	81-0475	81-1207	—
6	81-0475 (2 req'd)	81-1207 (2 req'd)	—
8	81-1163	81-1209	—
10	81-1163 (2 req'd)	81-1209 (2 req'd)	—
12	81-1164	81-1210	—
14	81-1164 (2 req'd)	81-1210 (2 req'd)	—

PRODUCTS



81-0323

OIL-FREE ADHESIVE

This is an oil-free product developed for use on viscous impingement type filters. It is a substitute for applications that do not permit oil wetting of the filter elements, such as oil-free compressors. Dürr Universal Oil-Free Adhesive is available in 13 oz. aerosol spray cans.



81-1234

FILTER RESTRICTION GAUGE

The Filter Restriction Gauge provides a convenient, accurate means of monitoring filter pressure drops as the filter element becomes increasingly loaded with dirt. Cartridge Filters and Filter silencers are standard with threaded connections for direct mounting of the gauge.

09

ASME Code

ASME Code Silencer and Pressure Vessel Manufacturing Capabilities _____

78

ASME Code

DÜRR UNIVERSAL ASME CODE SILENCER AND PRESSURE VESSEL MANUFACTURING CAPABILITIES

- The Dürr Universal plant in Muscoda, Wisconsin, USA became certified in 1983 by ASME to fabricate metallic pressure vessels. Since then they have built more than 3,800 “U” or “UM” vessels stamped to ASME Section VIII Div 1.
- Available in carbon steel, 304SS, 316SS, 304LSS, 316LSS, and more.
- Dürr Universal has a dedicated manufacturer in India that also manufactures pressure vessels.
- Dürr Universal has built many Canadian Registration Number (CRN) units for use in Canada.

CODE SILENCERS

Dürr Universal has more than 50 years of experience designing and manufacturing ASME Code pressure vessels and ASME Code silencers used in the most demanding applications.

- Operating pressure range from 15 to 3,000 PSIG.
- Recommended for applications with vacuum exceeding 20” mercury.
- Capable of handling hazardous or flammable gases.
- Commonly used on blowers, compressors, and vacuum pumps.
- Suitable for use with pressure-reduction valves and in-line filters.
- Any of our non-code cylindrical industrial silencers can be modified to a code design.

Features	Benefits
Pressure Vessel Design Calculations	Ensures Adequate Material Thickness
Certified Vessel Material	Ensures Correct Material Properties
2:1 Elliptical or High-Crown Heads	Better Head Stress Distribution
Forged Flanges	Improved Flange Strength and Durability
Inspection Openings are Required	Access Point to Monitor Vessel Condition
Qualified Welders and Procedures	Consistent Welding Results
Traveler Form	Material and Welder Traceability
Hydrostatic Test	Validates Vessel is Leak-Free
Data Report	Documents Materials and Construction
Third-Party Authorized Inspection	Independent and Experienced

10

Accessories

Dürr Universal offers single source supply for exhaust systems. An exhaust system is not complete without the accessories used to help complete a specific installation. The advantages of using one source are reduced paperwork and the knowledge that it will all fit at the job-site or on the production floor. Use the inlet size of the engine and the silencer to guide the selection process.

Accessories _____	80
Relief Covers and Inspection Openings _____	82
Straight Outlet Extensions _____	83
90° Outlet Extensions _____	84
Raincaps _____	85
Connectors _____	86
Silencer Attachment Brackets _____	88
Reduction/Oversize Flange Kit _____	89
Nut, Bolt and Gasket Kits - ANSI _____	90
Insulation Blankets _____	91
Weld-On Attachment Brackets _____	92
Weld-On Legs _____	95

Dürr Universal understands that each package design is unique. If an accessory item doesn't fit the dimensions required, Dürr Universal can make custom sizes. Just mark up the outline drawing of the nearest item in functionality and shape with the required dimensions and send it to us for a custom quote.

All information correct at time of printing. Dürr Universal has a policy of continuous improvement. Therefore we reserve the right to change the specifications of these silencers without notice.

Accessories

TECHNICAL PRESENTATION

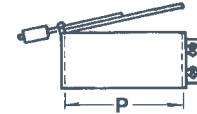
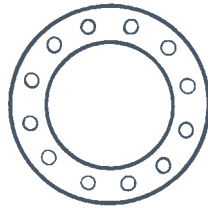
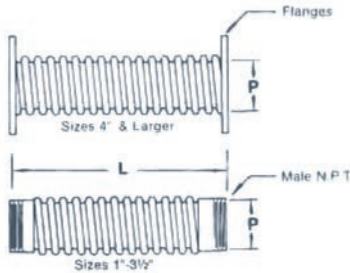

FLEX CONNECTORS

P (size)	L (Nominal)	Weight
1	18	4
1½	18	6
2	18	7
2½	18	9
3	18	10
3½	18	12
4	18	14
5	18	17
6	18	24
8	18	36
10	18	62
12	18	69
14	18	90
16	18	110
18	18	130

Note: Dimensions (in) and weights (lbs) are nominal and may vary slightly with production models. Request certified drawings of specific models for exact dimensions.

Flex Connectors are recommended for engine exhaust applications to compensate for thermal expansion and vibration (but not misalignment). Flexible material is type 321 stainless steel, suitable for temperatures to 1200°F. Flanges and pipe fittings are mild steel. Sizes 1"–3½" are standard with male NPT, larger sizes are equipped with flanges drilled to 125/150# ANSI.

COMPANION FLANGE SET

Pipe Size	Weight
4	7
5	10
6	13
8	16
10	30
12	35
14	45
16	55
18	65
20	90
22	105
24	115
26	130
28	150
30	160

Note: Dimensions (in) and weights (lbs) are nominal and may vary slightly with production models. Request certified drawings of specific models for exact dimensions.

Each Companion Flange Set includes one mild steel welding flange drilled to match 125/150# ANSI, one gasket, and one set of bolts and nuts. Cast iron threaded flanges and stainless steel flanges are available and will be quoted on request. Single and double reducing flanges are also available. For additional sizes and information, please contact Dürr Universal.

RAIN CAPS

Part Number	P (Fits Pipe Size)	Weight
80-1061	1	½
80-1062	1½	½
80-1063	2	1
80-1064	2½	1
80-1065	3	1
80-1066	3½	1½
80-1067	4	2
80-1068	5	2
80-1034	6	5½
80-1035	8	8
80-1036	10	11
80-1037	12	14
80-1038	14	22
80-1039	16	26
80-1040	18	30
80-1041	20	34
80-1042	22	36

Note: Dimensions (in) and weights (lbs) are nominal and may vary slightly with production models. Request certified drawings of specific models for exact dimensions.

Raincaps prevent rain, snow, and dust from entering the exhaust system. Non-corrosive bushings ensure positive opening. All sizes are standard mild steel a single-coat aluminum paint rated for 1000°F. Sizes 8"–22" are also available in stainless steel—quoted by request and equipped with adjustable counterweights.

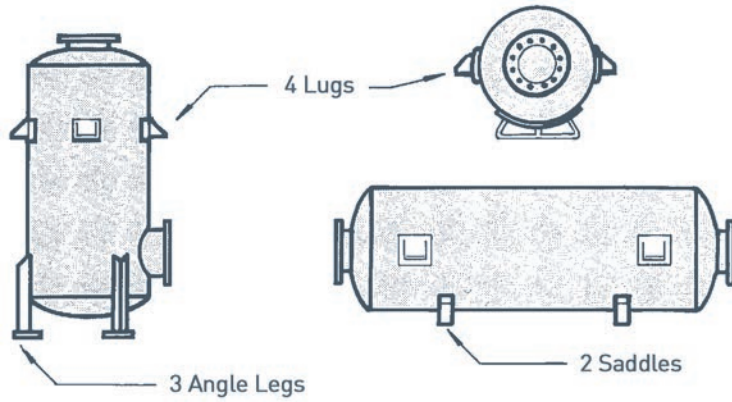

MOUNTING ATTACHMENTS

Mounting Attachments are welded in place on the silencer shell to facilitate installation. Standard and variable dimensions are available.

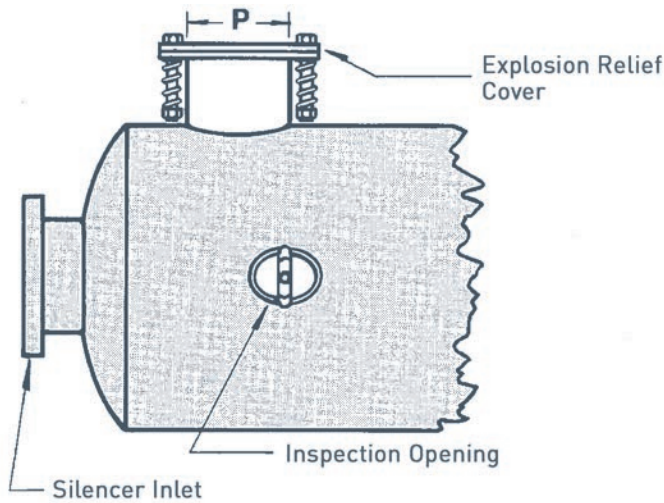

INSPECTION OPENINGS

Part Number	Inspection Opening Size (Oval)	Weight
80-1019	3 x 4	4
80-1020	4 x 6	6
80-1021	6 x 8	12

Note: Dimensions (in) and weights (lbs) are nominal and may vary slightly with production models. Request certified drawings of specific models for exact dimensions.

Inspection Openings have removable covers to provide access to silencer internals for inspection or cleaning. Usually one opening per silencer chamber is recommended.

EXPLOSION RELIEF COVER

Size Nom.	Part Number	Weight
8	80-0622	30
12	80-1059	50
16	80-1060	95
20	80-1053	130
26	80-1405	210

Note: Dimensions (in) and weights (lbs) are nominal and may vary slightly with production models. Request certified drawings of specific models for exact dimensions.

Explosion Relief Covers are designed to open at 5 PSI to protect the silencer shell against rupture in case of backfire or explosion of residual gases within exhaust system. One unit in first chamber of silencer is adequate.

Relief Covers and Inspection Openings

TECHNICAL PRESENTATION

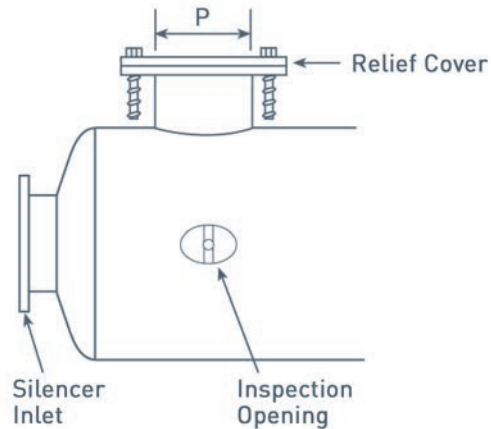

RELIEF COVER

Part Number	Silencer Body Diameter	Pressure Relief Cover Diameter	Weight
Q34361	10-14	4.125	4
Q34362	16-18	8.125	6
Q34363	22-26	8.250	10
Q34853	30-36	12.375	12
Q34854	42-48	16.000	14
Q34855	54-60	20.000	18

Note: Dimensions (in) and weights (lbs) are nominal and may vary slightly with production models. Request certified drawings of specific models for exact dimensions.

Explosion relief covers are designed to open at 5 PSI to protect silencer shell against rupture in case of backfire or explosion of residual gases within the exhaust system. One unit in the first chamber of silencer is adequate.

INSPECTION OPENING

Part Number	Insp. Opening Size	Weight
80-1019	3 x 4	4
80-1020	4 x 6	6
Q34822	5 x 7	6
80-1021	6 x 8	12
Q34852	8 x 10	12

Note: Dimensions (in) and weights (lbs) are nominal and may vary slightly with production models. Request certified drawings of specific models for exact dimensions.

Inspection openings have removable covers to provide access to silencer internals for inspection or cleaning. One opening per silencer is recommended.

Straight Outlet Extensions

Outlet extensions are used downstream from the silencer to direct the exhaust stream and dispersion pattern. Tubing is constructed of 16 Gauge Mild Steel. All assemblies are heli-arc welded to ensure that the base material is not undercut. All non-stainless steel material is coated in high temperature paint.

STRAIGHT CUT, NO BIRD SCREEN

Size	Part Number	B	A	Weight
4	80-3900	8.5	4	14
5	80-3901	10.5	5	14.5
6	80-3902	12.5	6	22
8	80-3903	16.5	8	28
10	80-3904	20.6	10	51
12	80-3905	24.6	12	71
14	80-3906	28.6	14	84
16	80-3907	28.5	16	91
18	80-3908	36	18	128
20	80-3909	40	20	158
22	80-3910	44	22	191

Note: Dimensions (in) and weights (lbs) are nominal and may vary slightly with production models. Request certified drawings of specific models for exact dimensions.

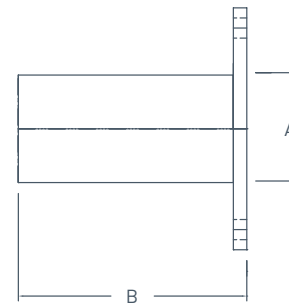

Sizes 4-12" – ANSI Light Flange Connection
 Sizes 14-22" – 125/150# ANSI Flange Connection

45° CUT WITH BIRD SCREEN

Size	Part Number	B	A	Weight
4	40340K	8.5	4	13
5	40350K	10.5	5	13.35
6	40360K	12.5	6	20
8	40380K	16.5	8	26
10	40382K	20.16	10	48
12	40384K	24.6	12	68
14	40386K	28.6	14	80
16	40388K	28.5	16	87
18	80-3865	36	18	124
20	80-3866	40	20	153
22	80-3867	44	22	185

Note: Dimensions (in) and weights (lbs) are nominal and may vary slightly with production models. Request certified drawings of specific models for exact dimensions.

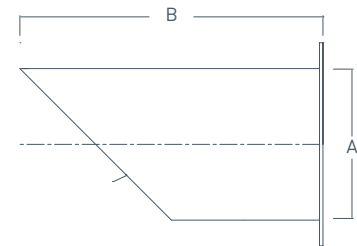

Sizes 4-12" – ANSI Light Flange Connection
 Sizes 14-22" – 125/150# ANSI Flange Connection

45° CUT END, NO BIRD SCREEN

Size	Part Number	B	A	Weight
4	80-3875	8.5	4	13
5	80-3876	10.5	5	13.35
6	80-3877	12.5	6	20
8	80-3878	16.5	8	26
10	80-3879	20.6	10	48
12	80-3880	24.6	12	68
14	80-3881	28.6	14	80
16	80-3882	28.5	16	87
18	80-3883	36	18	124
20	80-3884	40	20	153
22	80-3885	44	22	185

Note: Dimensions (in) and weights (lbs) are nominal and may vary slightly with production models. Request certified drawings of specific models for exact dimensions.

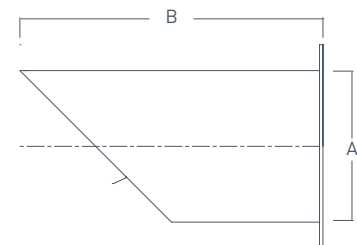

Sizes 4-12" – ANSI Light Flange Connection
 Sizes 14-22" – 125/150# ANSI Flange Connection

90° Outlet Extensions

Outlet extensions are used downstream from the silencer to direct the exhaust stream and dispersion pattern. Tubing is constructed of 16 Gauge Mild Steel. All assemblies are heli-arc welded to ensure that the base material is not undercut. All non-stainless steel material is coated in high-temperature paint.

FORMED 90° OUTLET ELBOW, WITH BIRD SCREEN

Size	Part Number (Carbon Steel)	Part Number (304SS)	A	B	C	Weight
4	40640K	80-4091	4	6.5	7.5	14
5	40650K	80-4092	5	8.5	9.0	16
6	40660K	80-4093	6	12.5	12.0	20

Note: Dimensions (in) and weights (lbs) are nominal and may vary slightly with production models. Request certified drawings of specific models for exact dimensions.

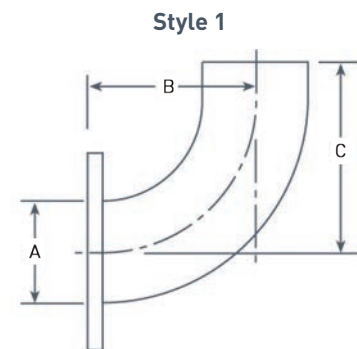

ANSI Light Flange Connection

3-PC MITERED 90° OUTLET ELBOW, WITH BIRD SCREEN

Size	Part Number (Carbon Steel)	Part Number (304SS)	A	B	C	Weight
8	40680K	80-4094	8.69	12	12	35
10	40682K	80-4095	10.81	14	14	55
12	40684K	80-4096	12.81	16	16	74
14	80-3868	80-3869	14	14	14	82
16	80-3870	80-3871	16	16	16	90
18	80-3872	80-3873	18	18	18	100
20	80-3918	80-3919	20	20	20	112

Note: Dimensions (in) and weights (lbs) are nominal and may vary slightly with production models. Request certified drawings of specific models for exact dimensions.

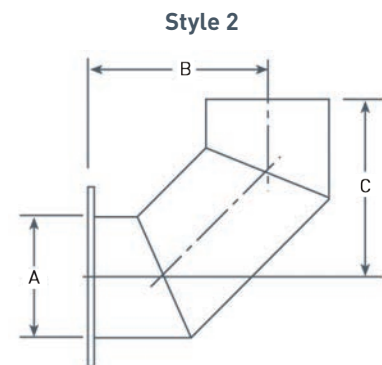

Sizes 8"–12" - ANSI Light Flange Connection
 Sizes 14"–22" - 125/150# ANSI Flange Connection

Raincaps

All non-stainless steel material is coated in high-temperature paint.

RAINCAPS: LIGHTWEIGHT

Size	Type	Part Number (Carbon Steel)	Part Number (304SS)	A	B	C	Weight
2	Tube	89420A	80-3501	2.06	1.63	0.88	1
2.5	Tube	89425A	80-2531	2.56	1.63	0.88	1
3	Tube	89430A	80-3513	3.06	1.63	0.88	1
3.5	Tube	84935A	80-2849	3.56	1.63	0.88	1.5
4	Tube	89440A	80-3515	4.06	1.63	0.88	2
4	Pipe	80-3531	80-3502	4.56	1.63	0.88	1.5
5	Tube	89450A	80-3516	5.06	1.63	0.88	2
5	Pipe	80-3532	80-3503	5.63	1.63	0.88	2
6	Tube	89460A	80-3517	6.06	1.63	0.88	5.5
6	Pipe	80-3533	80-3504	6.69	1.63	0.88	5.5

Note: Dimensions (in) and weights (lbs) are nominal and may vary slightly with production models. Request certified drawings of specific models for exact dimensions.

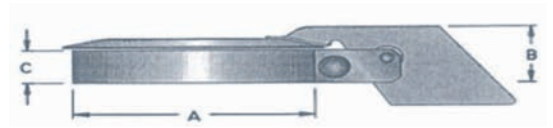

RAINCAPS: STANDARD HEAVY DUTY

Size	Type	Part Number (Carbon Steel)	Part Number (304SS)	A	B	C	Weight
8	Tube	89480A	80-3518	8.06	7.13	2.63	8
8	Tube	89483A	N/A	8.40	7.13	2.63	8
8	Pipe	80-3534	80-3514	8.69	7.13	2.63	8
10	Tube	84982A	80-3519	10.06	7.13	2.63	11
10	Tube	89495A	N/A	10.40	7.13	2.63	11
10	Pipe	80-3535	80-3511	10.81	7.13	2.63	11
12	Tube	89484A	80-3520	12.06	7.13	2.63	14
12	Tube	89498A	N/A	12.40	7.13	2.63	14
12	Pipe	80-3536	80-3500	12.81	7.13	2.63	14
14	Pipe	89486A	80-2306	14.06	7.13	2.63	22
16	Pipe	89488A	80-2475	16.06	7.13	2.63	26
18	Pipe	89492A	80-2473	18.06	7.13	2.63	30
20	Pipe	89494A	80-3512	20.06	8.63	4.00	34
22	Pipe	89496A	80-2474	22.06	8.63	4.00	36

Note: Dimensions (in) and weights (lbs) are nominal and may vary slightly with production models. Request certified drawings of specific models for exact dimensions.

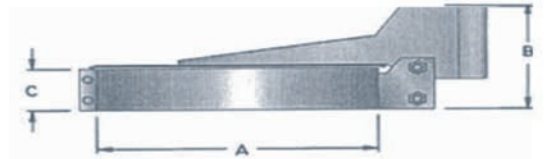

Connectors

Outlet extensions are used downstream from the silencer to direct the exhaust stream and dispersion pattern. Tubing is constructed of 16 Gauge Mild Steel. All assemblies are heli-arc welded to ensure that the base material is not undercut. All non-stainless steel material is coated in high-temperature paint.

EXPANSION CONNECTORS - ANSI FLANGE BOTH ENDS

Pipe Size	Part Number	A	B	C	D	Weight
6	80-3944	6	8	10	9.5	24
6	80-3945	6	10	12	18.8	36
8	80-3946	8	10	12	9.5	48
8	80-3947	8	12	12	18.8	58
10	80-3948	10	12	12	9.5	72
10	80-3949	10	14	12	18.8	84
12	80-3950	12	14	12	9.5	101
12	80-3951	12	16	12	18.8	115
14	80-3952	14	16	14	8.2	157
14	80-3953	14	18	14	16	176
16	80-3954	16	18	16	7.2	230
16	80-3955	16	20	16	14.2	256
18	80-3956	18	20	16	7.2	288
18	80-3957	18	22	16	14.3	317
20	80-3958	20	22	16	7.2	352
20	80-3959	20	24	16	14.3	384
22	80-3960	22	24	16	7.2	422
22	80-3961	22	26	16	14.3	458

Note: Dimensions (in) and weights (lbs) are nominal and may vary slightly with production models. Request certified drawings of specific models for exact dimensions.

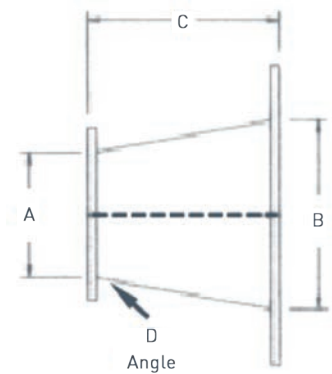

STRAIGHT TUBE ANSI FLANGES - BOTH ENDS

Pipe Size	Part Number Square End	A	L	Weight
4	80-3920	4.50	12	10
5	80-3921	5.56	15	12
6	80-3922	6.63	18	19
8	80-3923	8.63	18	31
10	80-3924	10.75	20	58
12	80-3925	12.75	24	69
14	80-3926	14.00	28	90
16	80-3927	16.00	32	120
18	80-3928	18.00	36	151
20	80-3929	20.00	40	186
22	80-3930	22.00	44	225

Note: Dimensions (in) and weights (lbs) are nominal and may vary slightly with production models. Request certified drawings of specific models for exact dimensions.

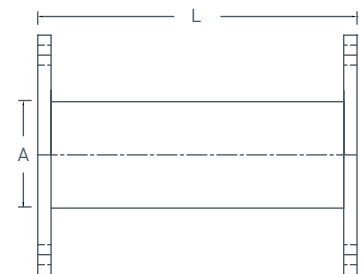

Sizes 4"-12" – ANSI Light Flange Connection
 Sizes 14"-22" – 125/150# ANSI Flange Connection
 Custom sizes are available.

90° FORMED TUBE ELBOWS - ANSI FLANGE BOTH ENDS

Tube Size	Part Number	L1	L2	Weight
4	80-4055	8	8	16
5	80-4056	10	10	20
6	80-4057	12	12	30

Note: Dimensions (in) and weights (lbs) are nominal and may vary slightly with production models. Request certified drawings of specific models for exact dimensions.

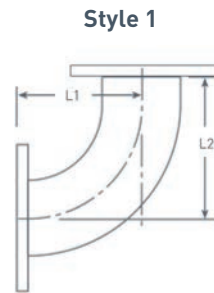

3-PC MITERED 90° ELBOWS - ANSI FLANGE BOTH ENDS

Pipe Size	Part Number	L1	L2	Weight
8	80-4065	8	8	17
10	80-4066	10	10	26
12	80-4067	12	12	35
14	80-4068	14	14	55
16	80-4069	16	16	74
18	80-4070	18	18	92
20	80-4071	20	20	118
22	80-4072	22	22	142

Note: Dimensions (in) and weights (lbs) are nominal and may vary slightly with production models. Request certified drawings of specific models for exact dimensions.

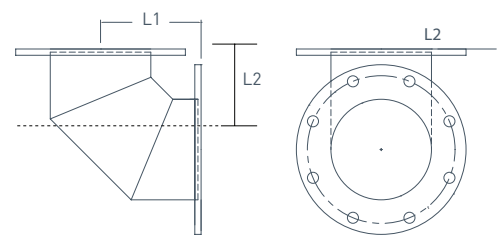

Silencer Attachment Brackets

Attachment brackets and clamps are used to attach the silencer to a substructure such as a wall or enclosure cabinet. Brackets are constructed of mild steel. Style 1, single piece, is recommended on smaller diameter silencers (<16"), and Style 2 is recommended on larger diameter silencers (>14") for ease of installation.

SILENCER ATTACHMENT BRACKETS, STYLE 1

Inside Diameter A	Part Number (Carbon Steel)	Part Number (304SS)	B	Bolt Hole C	D	Band Width F	Weight
5	80-3975	80-3998	2.5	0.313	3.0	1.00	0.7
6	80-3977	80-4000	3	0.313	3.6	1.25	0.8
8	80-3980	80-4001	4	0.313	4.8	1.50	1.5
10	Q27240	80-4002	5	0.375	6.0	2.00	1.7
12	Q27241	80-4003	5	0.375	7.2	2.50	1.8
14	Q27242	80-4004	6	0.375	8.4	3.00	2.0

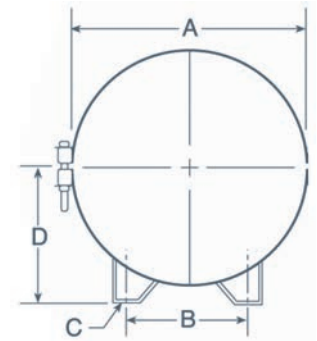

Specifications are subject to change without notice, all dimensions are in inches. Sold in quantities of one.
Note: Dimensions (in) and weights (lbs) are nominal and may vary slightly with production models. Request certified drawings of specific models for exact dimensions.

SILENCER ATTACHMENT BRACKETS, STYLE 2

Inside Diameter A	Part Number (Carbon Steel)	Part Number (304SS)	B	Bolt Hole C	D	Band Width F	Weight
16	Q27243	80-3963	6	.50	8.90	2.00	5.5
18	Q27244	80-3964	9	.50	11.12	2.00	6
20	80-3988	80-3965	10	.50	12.06	2.50	9.5
22	Q27245	80-3966	11	.50	13.63	2.50	10.5
24	80-3990	80-3967	12	.63	14.56	2.50	11.5
26	Q27246	80-3968	13	.63	15.44	3.00	17.5
30	Q27247	80-3970	15	.63	17.25	4.00	27
36	Q27248	80-3972	18	.63	20.12	4.00	33
42	80-3997	80-3974	21	.75	28.38	4.00	44
48	80-3999	80-3976	24	1	26.50	4.00	63

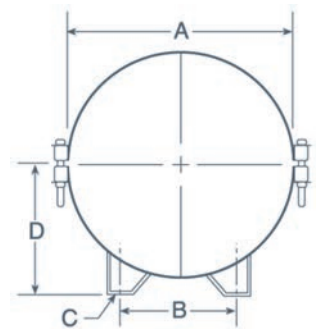

Split design allows for easier installation of larger silencers. Sold in quantities of one.
Note: Dimensions (in) and weights (lbs) are nominal and may vary slightly with production models. Request certified drawings of specific models for exact dimensions.

Reduction/Oversize Flange Kits

Frequently the engine's flange size is larger than the required silencer's connection. Rather than use a larger silencer, it is usually more economical to use an oversize reducing flange on the silencer. Dürr Universal offers single reduction and double reduction ANSI Flange.

REDUCTION FLANGE: SINGLE

Pipe Size Reduction	Part Number	A	B	C	D	E	# of Holes	Weight
5 x 4	82-1239	4.56	8.50	0.875	10.00	0.500	8	6
6 x 5	82-1240	5.63	9.50	0.875	11.00	0.500	8	9
8 x 6	82-1241	6.69	11.75	0.875	13.50	0.500	8	14.5
10 x 8	82-1242	8.75	14.25	1.000	16.00	0.500	12	17
12 x 10	82-1243	10.88	17.00	1.000	19.00	0.500	12	26
14 x 12	82-1244	12.88	18.75	1.125	21.00	0.500	12	29
16 x 14	82-1245	14.19	21.25	1.125	23.50	0.500	16	37
18 x 16	82-1246	16.19	22.75	1.250	25.00	0.500	16	38
20 x 18	82-1247	18.19	25.00	1.250	27.50	0.500	20	44
22 x 20	82-1248	20.19	27.25	1.375	29.50	0.500	20	47
24 x 22	82-1249	22.19	29.50	1.375	32.00	0.500	20	55

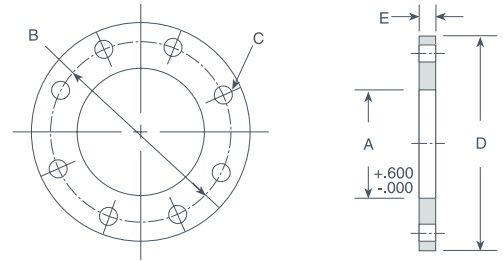

Note: Dimensions (in) and weights (lbs) are nominal and may vary slightly with production models. Request certified drawings of specific models for exact dimensions.

REDUCTION FLANGE: DOUBLE

Pipe Size Reduction	Part Number	A	B	C	D	E	# of Holes	Weight
6 x 4	82-1343	4.56	9.50	0.875	11.00	0.500	8	10.5
8 x 5	82-1344	5.63	11.75	0.875	13.50	0.500	8	16
10 x 6	82-1345	6.69	14.25	1.000	16.00	0.500	12	22
12 x 8	82-1346	8.75	17.00	1.000	19.00	0.500	12	30
14 x 10	82-1347	10.88	18.75	1.125	21.00	0.500	12	34
16 x 12	82-1348	12.88	21.25	1.125	23.50	0.500	16	41
18 x 14	82-1349	14.19	22.75	1.250	25.00	0.500	16	44
20 x 16	82-1350	16.19	25.00	1.250	27.50	0.500	20	52
22 x 18	82-1351	18.19	27.25	1.375	29.50	0.500	20	56
24 x 20	82-1352	20.19	29.50	1.375	32.00	0.500	20	64
26 x 22	82-1353	22.19	31.75	1.375	34.25	0.750	24	106

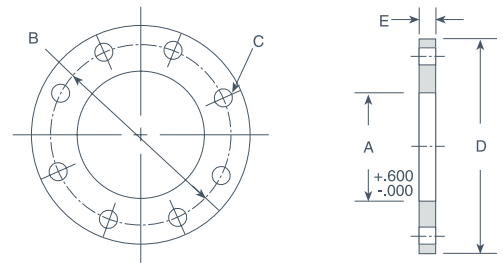

Note: Dimensions (in) and weights (lbs) are nominal and may vary slightly with production models. Request certified drawings of specific models for exact dimensions.

Nut, Bolt, and Gasket Kits - ANSI

Each nut, bolt, and gasket kit contains a ring gasket and a bolt and nut for each hole.

NUT, BOLT, AND GASKET KITS - ANSI

Pipe Size	Part Number	d	D	# of Holes	H	Thickness	Weight
4	Q347458	4.50	6.88	8	0.750	.060	4
5	Q347459	5.56	7.75	8	0.875	.060	4.25
6	Q347460	6.63	8.75	8	0.875	.060	4.5
8	Q347461	8.63	11.00	8	0.875	.060	5
10	Q347462	10.75	13.38	12	1.000	.060	8
12	Q347463	12.75	16.13	12	1.000	.060	11
14	Q347464	14.00	17.75	12	1.125	.060	14
16	Q347465	16.00	20.25	16	1.125	.060	19
18	Q347466	18.00	21.63	16	1.250	.120	26
20	Q347467	20.00	23.88	20	1.250	.120	30
22	Q347468	22.00	26.00	20	1.375	.120	34

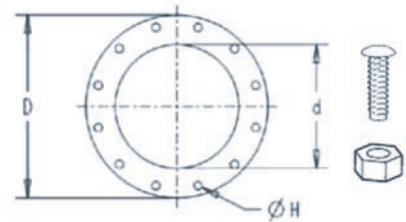

Gaskets are made from metal graphite and fiber material for durability. Gaskets are rated to 1400°F (760°C).
Note: Dimensions (in) and weights (lbs) are nominal and may vary slightly with production models. Request certified drawings of specific models for exact dimensions.

FULL FACE GASKETS

Pipe Size	Part Number	d	D	# of Holes	H	Thickness	Weight
4	903278	4.50	9.00	8	0.750	.060	.3
5	903279	5.56	10.00	8	0.875	.060	.3
6	903280	6.63	11.00	8	0.875	.060	.3
8	903281	8.63	13.50	8	0.875	.060	.3
10	903282	10.75	16.00	12	1.000	.060	.3
12	903283	12.75	19.00	12	1.000	.060	.6
14	903284	14.00	21.00	12	1.125	.060	.6
16	903285	16.00	23.50	16	1.125	.060	.6
18	903286	18.00	25.00	16	1.250	.120	.6
20	903287	20.00	27.50	20	1.250	.120	.6
22	903288	22.00	29.50	20	1.375	.120	.6

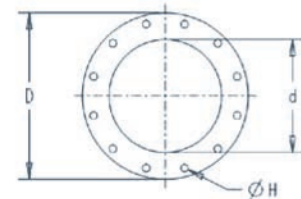

Gaskets are made from metal graphite and fiber material for durability. Gaskets are rated to 1400°F (760°C).
Note: Dimensions (in) and weights (lbs) are nominal and may vary slightly with production models. Request certified drawings of specific models for exact dimensions.

RING GASKETS

Pipe Size	Part Number	d	D	# of Holes	H	Thickness	Weight
4	Q04166	4.50	6.88	N/A	N/A	.060	.25
5	Q04167	5.56	7.75	N/A	N/A	.060	.25
6	Q04168	6.63	8.75	N/A	N/A	.060	.25
8	Q04169	8.63	11.00	N/A	N/A	.060	.25
10	Q04170	10.75	13.38	N/A	N/A	.060	.25
12	Q04171	12.75	16.13	N/A	N/A	.060	.5
14	Q04172	14.00	17.75	N/A	N/A	.060	.5
16	Q79468	16.00	20.25	N/A	N/A	.060	.5
18	Q79469	18.00	21.63	N/A	N/A	.120	.5
20	Q79470	20.00	23.88	N/A	N/A	.120	.5
22	Q79471	22.00	26.00	N/A	N/A	.120	.5

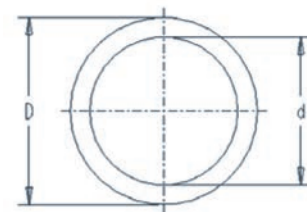

Gaskets are made from metal graphite and fiber material for durability. Gaskets are rated to 1400°F (760°C).
Note: Dimensions (in) and weights (lbs) are nominal and may vary slightly with production models. Request certified drawings of specific models for exact dimensions.

Insulation Blankets

TECHNICAL PRESENTATION

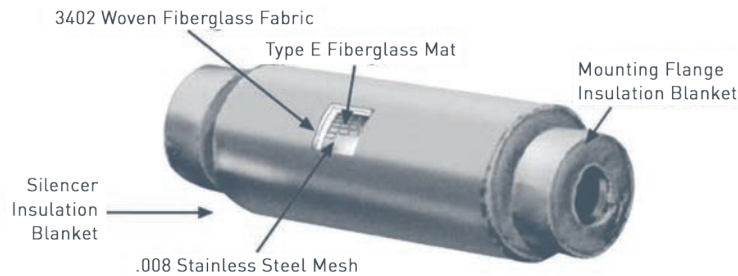

BENEFITS

Insulation blankets on your diesel exhaust systems offer the following benefits:

- Reduce external system surface temperature by as much as 1,000°F .
- Silence sound by as much as 3 dB.
- Substantially reduce heat transfer into buildings and enclosures.
- Multi-use; remove and reuse on other diesel exhaust systems.

ABOUT THE BLANKETS

Dürr Universal brand insulated blankets are constructed of three unique plies:

Inside Ply is made of a knitted stainless steel wire mesh.

Middle Ply is a Type E fiberglass insulation*.

Outer Ply is made from silicone-impregnated fiberglass fabric.

High-temperature resistant silicone provides significantly longer life and improved resistance to abrasion, flexing wear, tears, and punctures. The heavy-duty, inner-lining fabric is resistant to oils and acids/alkalis, as well as being flame retardant.

All blanket edges are machine-stitched using high grade fiberglass thread and fastened with permanently mounted, stainless steel hooks. The blankets are laced in place "boot-style" with stainless steel tie wire, resulting in a custom-made "glove fit."

*Type E fiberglass insulation is designed for insulation within high-temperature equipment. It is manufactured from chopped fiberglass fibers and is free of resinous binders, which enables its use in the high-temperature ranges. Type E insulation is flexible, lightweight, and will not compact under vibration.

SPECIFICATIONS

Each insulation blanket conforms with the requirements of Military Specifications MIL-I-164-E, Type II

ORDERING INFORMATION

Please contact your QuietShield representative to receive an insulation blanket quote on a QuietShield model. QuietShield offers low skin temperature designs as standards in Type 1 and Type 3 configuration Ultra-Quiet grade, and Type 2 configuration Critical and Hospital grades. Therefore, insulation blankets are not required for these models.

Weld-On Attachment Brackets

Dürr Universal provides several options for attaching the silencer to a structure or floor. Vertical silencer installations have a Type 1 or 3 attachment option. Horizontal silencer installations have a Type 2 or Type 4 attachment option. Please indicate attachment option on order. The brackets and legs will be factory installed so no field welding is required.

TECHNICAL PRESENTATION

VERTICAL INSTALLATION

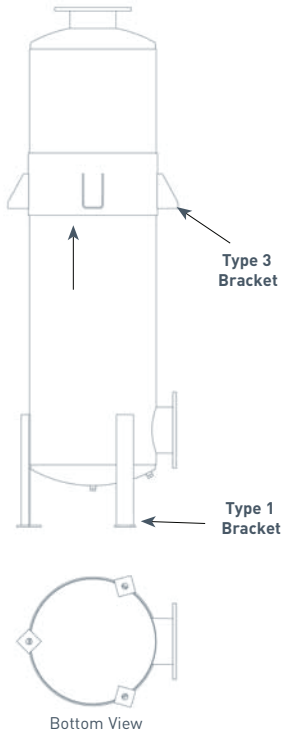

HORIZONTAL INSTALLATION

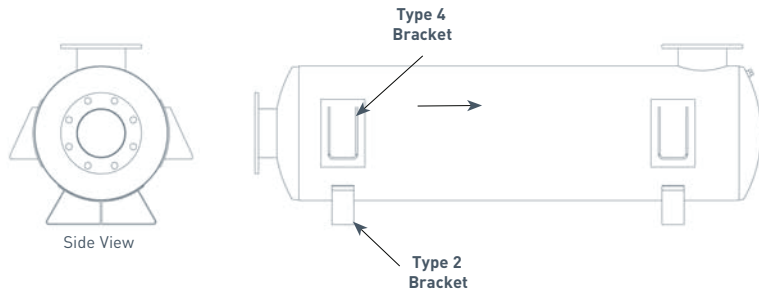

VERTICAL SHELL LUGS (TYPE 3)

Body Diameter (Ø Head)	Bolt Circle Diameter (B.C.D.)	Slot Diameter	Slot Center
8	10.38	0.5	0.5
10	13.63	0.75	0.63
12	15.63	0.75	0.63
14	17.63	0.75	0.63
16	19.63	0.75	0.63
18	23.50	1	0.88
20	25.56	1	0.88
22	27.56	1	0.88
24	29.56	1	0.88
26	31.56	1	0.88
30	35.63	1	0.88
36	41.63	1	0.88
42	49.63	1.25	1.25
48	55.75	1.25	1.25
54	61.75	1.25	1.25
60	67.75	1.25	1.25
66	74	1.25	1.25

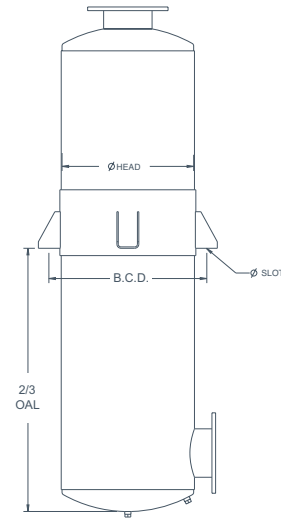

Note: Dimensions (in) and weights (lbs) are nominal and may vary slightly with production models. Request certified drawings of specific models for exact dimensions.

HORIZONTAL SHELL LUGS (TYPE 4)

Body Diameter (Ø Head)	Bolt Circle Diameter (B.C.D.)	Hole Diameter
8	10.38	0.5
10	13.63	0.75
12	15.63	0.75
14	17.63	0.75
16	19.63	0.75
18	23.50	1
20	25.56	1
22	27.56	1
24	29.56	1
26	31.56	1
30	35.63	1
36	41.63	1
42	49.63	1.25
48	55.75	1.25
54	61.75	1.25
60	67.75	1.25
66	74	1.25

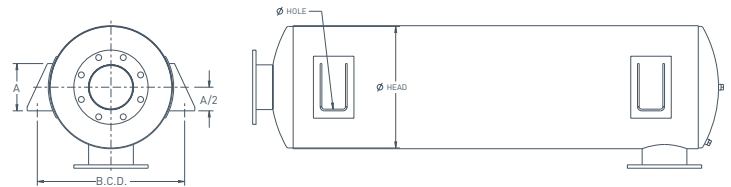

Note: Dimensions (in) and weights (lbs) are nominal and may vary slightly with production models. Request certified drawings of specific models for exact dimensions.

Specify distance between shell lugs on order. Otherwise lugs are placed approximately 1/4 of overall length, from each end of the body.

Weld-On Attachment Brackets

MOUNTING SADDLES (TYPE 2)

Body Diameter	A	B	Bolt Slots	Saddle Thickness
8	3.5	7.375	0.625	0.1345
10	5.5	8.375	0.625	0.1345
12	6.5	9.375	0.625	0.1345
14	9	10.375	0.75	0.1345
16	9	11.375	0.75	0.1345
18	11	12.375	1	0.1345
20	12	13.375	1	0.1345
22	12.5	14.5	1	0.1875
24	13	15.5	1	0.1875
26	15	16.5	1	0.1875
30	17	18.625	1	0.25
36	19	21.625	1.25	0.25
42	23	24.625	1.25	0.25
48	26	28	1.25	0.375
54	30	31	1.375	0.375
60	34	34	1.375	0.375
66	37	37	1.375	0.375

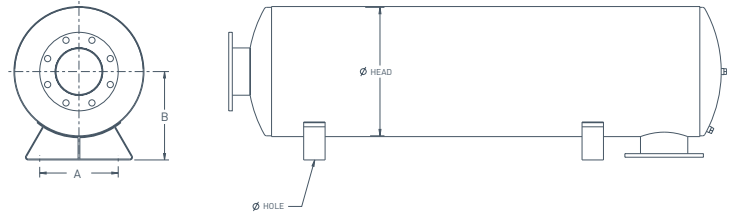

Note: Dimensions (in) and weights (lbs) are nominal and may vary slightly with production models. Request certified drawings of specific models for exact dimensions.

Specify distance between saddles on order. Otherwise saddles are placed approximately 1/4 of overall length, from each end.

Weld-On Legs

LEGS (TYPE 1)

Body Diameter (∅ Head)	Bolt Circle Diameter (B.C.D.)	Bolt Hole	Base Pad Thickness (A)	Base Pad Width
8	7.81	0.88	0.1875	1.5
10	10.19	0.88	0.25	2.5
12	12.25	0.88	0.25	2.5
14	14.25	0.88	0.25	2.5
16	16.31	0.88	0.25	2.5
18	18.38	0.88	0.25	2.5
20	20	1	0.375	4
22	22	1	0.375	4
24	24.06	1	0.375	4
26	26.06	1	0.375	4
30	30.06	1	0.375	4
36	36.13	1.25	0.5	5
42	42.19	1.25	0.5	5
48	48.25	1.25	0.5	5
54	54.13	1.375	0.75	7
60	60.13	1.375	0.75	7
66	66.38	1.375	0.75	7

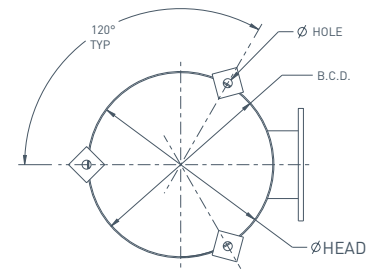
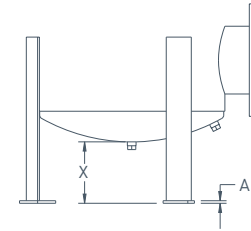

Note: Dimensions (in) and weights (lbs) are nominal and may vary slightly with production models. Request certified drawings of specific models for exact dimensions.

X dim represents specified height, 0 to 42". Specify X dimension on order.
Options for 4 legs are available. Please contact your Dürr Universal rep for details.



The information contained herein is provided for general information purposes only and is not intended nor is it to be construed as a warranty, an offer, or any representation of contractual or other legal responsibility. Durr Universal, Inc. All rights reserved.



Durr Universal, Inc.
1925 US Hwy 51 and 138
Stoughton, WI 53589
USA

Phone +1 888 300-4272
E-mail us@universalaet.com
Web www.durr-universal.com